



Kirkpatrick.



## CONTENTS

02	Handmade and British	82	BLACKSMITH FORGE RANGE
05	Our history	84	Door furniture
06	Why choose us?	88	Window furniture
08	Ranges and finishes	90	Hooks and handles
10	BLACK IRON RANGE	92	CAST BRASS RANGE
12	<b>Door and gate furniture</b>	93	Door furniture
12	Lever handles	99	Window furniture
18	Hinges and hinge fronts	100	Hooks, handles and locks
24	Thumb and gate latches	102	RAWNSLEY RANGE
30	Letter plates	104	INSPIRATION AND WHERE TO BUY
33	Bolts and locks	106	GLOSSARY
40	Pull handles	108	PRODUCT INDEX
44	Door knobs		
48	Door knockers		
52	Door accessories		
60	<b>Gate fittings</b>		
60	Gate stops and catches		
60	Locking bars/Hasp and staples		
62	<b>Window furniture</b>		
62	Casement fasteners		
67	Casement stays		
72	<b>Cabinet and drawer furniture</b>		
73	Handles		
74	Knobs and pulls		
76	<b>Home accessories</b>		
76	Hooks and brackets		
80	Lighting		
81	Patio and fireside		



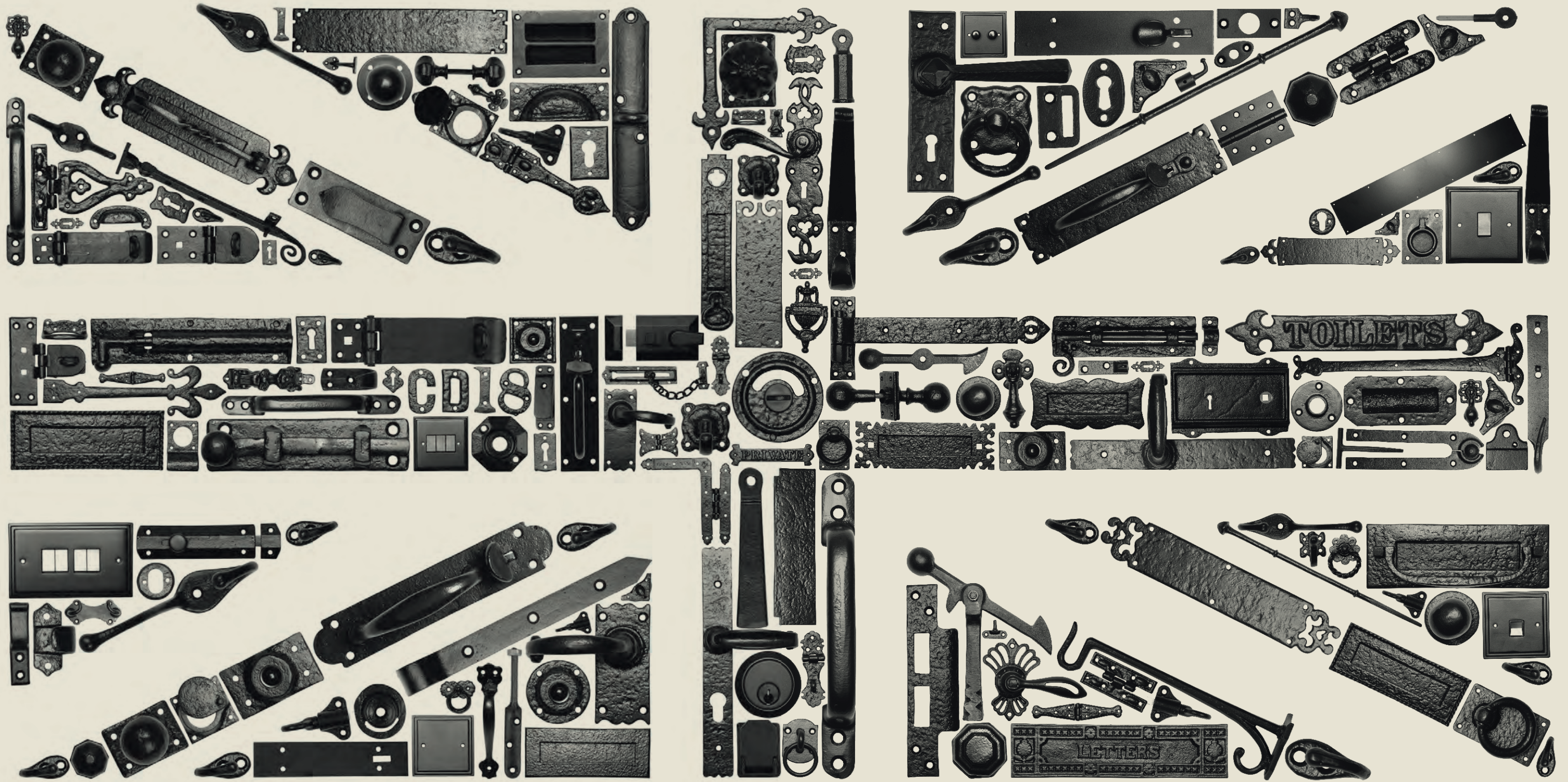



# HANDMADE AND BRITISH FROM START TO FINISH

We have more than 160 years' experience, crafting beautiful ironwork under the same roof in Walsall where it all began back in 1855.

## OUR HISTORY



Our business was founded by William Kirkpatrick, Esq. J. P. (1817-1887) in Walsall in 1855, and carried on for many years in his name and direction.

His son, Vincent Kirkpatrick, succeeded his father and presided over the incorporation of the business as a Limited Company in 1901. Upon incorporation, many loyal and long serving employees were given a shareholding, starting a tradition which continues to this day.

Many of the descendants of those first shareholders still retain their interest in the Company and the Kirkpatrick family still also retain a shareholding.

### Adapting to change

While looking back through our large collection of product catalogues dating back to the 19th century, much of our present window and door furniture remains true to our roots and has changed little over the past 160 years.

But we've not stood still - apart from during both World War I and II, when production was interrupted to concentrate on the war effort, we've been constantly evolving to reflect changing tastes, fashions and technology. For example, many of our window fasteners now include secure locking mechanisms and we also supply products to suit modern UPVC windows and doors.



### The last UK foundry

In the mid-20th century there were many jobbing foundries in the Midlands and the Black Country, however most have fallen by the wayside owing to increasing international competition from India and the Far East.

As a result, we are immensely proud to be the only manufacturer of traditional black ironmongery left in the UK who genuinely pours their own metal.

Our continued success is due to the world-class quality of our genuinely hand-made products and our ability to adapt and develop our range to suit the needs of an ever changing world.

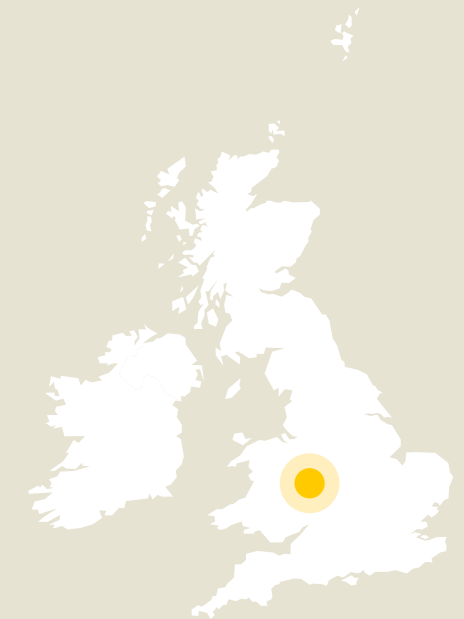



## FROM POURING TO PACKING...

...each stage is performed by our own fair hands – making us the only ironwork company whose products are genuinely handmade in Britain from start to finish.

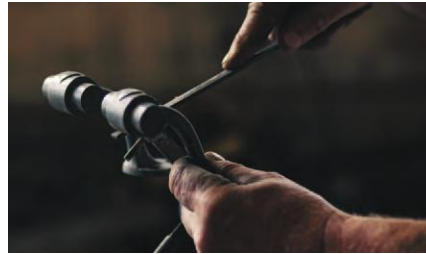

### STAGE 1 PATTERN MAKING

Dave gets the ball rolling by creating the distinctive patterns from which every Kirkpatrick product is born.



### STAGE 2 MOULDING

Chris skilfully makes the moulds by pressing the patterns into a special box filled with black sand.



### STAGE 3 MELTING

Paul adds pig iron to the induction furnace, which is heated to a melting point of 1,200 °C.



### STAGE 4 COLLECTING

Kevin collects the molten iron as it is poured from the tipped furnace into pre-heated pots.



### STAGE 5 POURING

Ransford needs a steady hand to evenly pour the molten iron into different moulds.



### STAGE 6 COOLING

David removes the heavy weights from moulds (which stop the iron exploding) and it begins to cool.

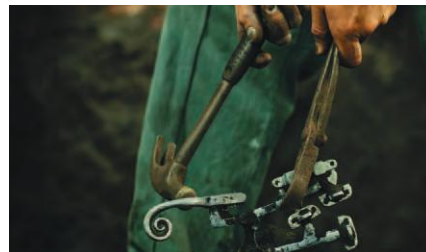

### STAGE 7 REMOVING

Dave moves the moulds and taps off the sand, to reveal the fresh new casting underneath.



### STAGE 8 SHOT BLASTING

Stuart puts the castings with metallic shot into a barrelling machine to smooth away rough edges.



### STAGE 9 ANNEALING

Mark places the castings into pots which are heated to 1,000 °C – making the iron strong yet malleable.



### STAGE 10 SORTING

Martin takes the castings, which have undergone further shot blasting, and separates each into storage boxes.



### STAGE 11 GRINDING

David grinds away the rough edges and unwanted seams to give the castings a smarter finish.

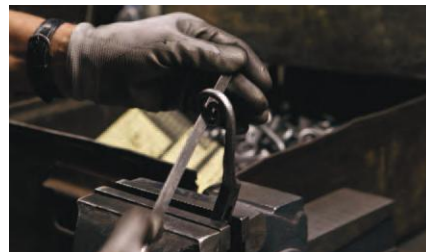

### STAGE 12 FILING

Bill completes the smoothing and rounding of each individual piece with a quick file down.



### STAGE 13 DRILLING

Sandra hand drills individual holes on each casting for accuracy and to give a high quality, durable finish.



### STAGE 14 ASSEMBLING

Dave assembles a range of our products by attaching, hammering and expertly screwing them together.

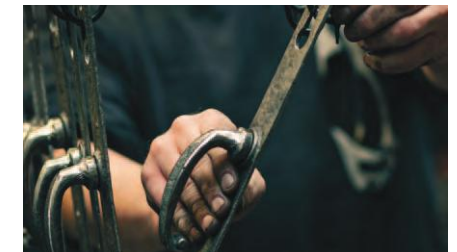

### STAGE 15 DIPPING

Michael makes sure the castings never rust by hanging and dipping each one in protective paint.



### STAGE 16 COATING

Dean sprays our products with a powder coating for a great finish, before baking them again for extra durability.



### STAGE 17 PACKING

Tracy makes sure every product is packed with the same care and attention that goes into making them.



### STAGE 18 SENDING

Mark works hard to ensure every customer receives their Kirkpatrick products in good time.



### STAGE 19 ENJOYING

It takes over six weeks to create every Kirkpatrick product, each providing a lifetime of enjoyment.





## WHY CHOOSE US?

We believe our 160-year tradition for producing handmade ironmongery, utilising the skills of our local workforce, gives Kirkpatrick products a style, authenticity and longevity that cannot be matched by less expensive, poor quality imitations.

It is a combination of our experience, expertise and dedication to producing ironwork of the utmost character which means that you will not find better quality or value anywhere else in the world.

### **Our heritage**

Much of our black iron door and window furniture is based on patterns (designs) used by our foundry since its inception in the 19th century. Our workforce today uses essentially the same finishing and assembly techniques as back then, which have been handed down and refined through generations.

It's this history which helps us create durable and beautiful ironwork products that have an integrity and authenticity which is second to none.

### **Our craft**

Each and every piece of our ironmongery is lovingly crafted by hand over a six week period, ensuring each door handle and window latch is unique and lovingly created to provide strength and quality which will last a lifetime.

Added to this, we react quickly and efficiently to our customer's needs, and are able to produce new fittings that perfectly match the style and character of old buildings.

### **Our promise**

We keep most of our products in stock and aim to deliver within 48 hours. So if you're trying to find a match for existing traditional ironwork or perhaps want to fit out a stylish new barn conversion, we're sure to have what you need.

We can supply everything from door and window furniture to coat hooks and shelf brackets, but if you can't find what you are looking for please get in touch as we are also able to create bespoke, one-off pieces to suit your exact needs.

### **Our authenticity**

We use malleable iron, because it is stronger and more durable than imported alternatives. This authenticity, coupled with the high quality of our products has made us recognised leaders in our field.

We're proud to be the only traditional ironmongery manufacturer able to use the Made in Britain logo. Why buy a traditional British product steeped in history from India or China?

### **Our guarantee**

We are proud of our heritage and the quality of our malleable iron products. Crafted to the highest standards using traditional manufacturing processes we are confident that you cannot buy a better quality product.

Care instructions are included in each product and by adopting this simple advice you can help ensure that Kirkpatrick Ironmongery will remain highly decorative and will last a lifetime.

### **Our green creds**

Although we are a traditional company, we're always looking for ways to improve our efficiency and therefore our environmental impact – so we've invested in reducing our energy consumption which has helped us save 250 tonnes of carbon each year since we upgraded our processes.

Our factory emissions are minimal and regularly tested to ensure we comply with the Environmental Protection Act and as a result – our carbon footprint is lower than many of our competitors who use foundries in unregulated countries and whose products have been imported into the UK.



## RANGES



### BLACK IRON

Our Black Iron range is the largest available anywhere in the world. Pieces range from traditional to contemporary in style in an Antique or Smooth Black Iron finish, with other finishes available on certain products. *(See page 10)*



### CAST BRASS

Our Cast Brass range is modelled from select pieces from our Black Iron range, which are made entirely from brass so the manufacturing process used differs from our black iron pieces. The component parts are highly polished before assembly and then have a tough lacquer applied to protect the product. *(See page 92)*



### BLACKSMITH FORGE

Our stylish new Blacksmith Forge range has been inspired by the iconic Gothic architecture of the late medieval period. It includes both door and window furniture, plus other fittings, and comes in a flat matt black or Argent finish to suit both traditional and contemporary-styled homes. *(See page 82)*



### RAWNSLEY

The Rawnsley range is based on ornate patterns rescued from a foundry on Cannock Chase which closed in the early 1980s. Some of the patterns are also to be found in old Kirkpatrick catalogues. The Rawnsley range is available in Black, Pewter and Argent finishes. *(See page 102)*

## FINISHES



### AB ANTIQUE BLACK

A stippled and slightly glossy black iron finish gives our products a unique texture. This is achieved by using antique style castings and the application of our tough powder coat protection. Products which have moving parts are also subjected to a prior coat of paint for additional protection.



### SB SMOOTH BLACK

A smooth matt textured, black iron finish. Although many products look similar to those with an Antique Black finish these differ because we use a smooth style pattern. The same paint and powder process as Antique Black is generally used.

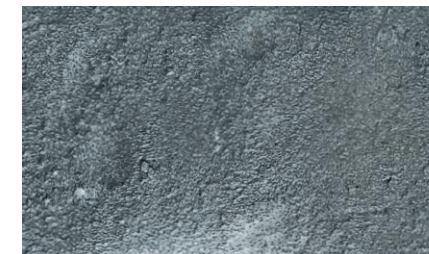

### A ARGENT

Argent has a slight stippled 'naked' silver metal finish which creates subtle highlights in differing lights. It differs from Pewter in that it is a bare metal finish with a coat of clear lacquer applied for protection.



### P PEWTER

Our Pewter finish is achieved by using a different colour final coating to give a long lasting Pewter effect. This finish is available on all products.

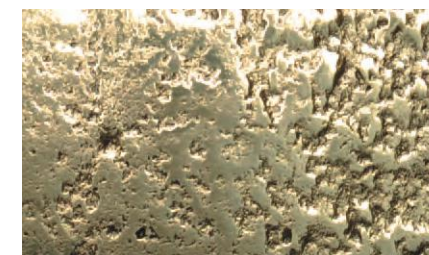

### B BRASS

Our original and authentic patterns are used to produce our Cast Brass range, and after casting the components are polished and then assembled by hand, finally finished with a tough lacquer to offer protection against corrosion.



# BLACK IRON RANGE

- 12 Door and gate furniture
- 60 Gate fittings
- 62 Window furniture
- 72 Cabinet and drawer furniture
- 76 Home accessories

*The traditional handcrafted nature of our production process means that all listed sizes are approximate.*



Door hinges 978 and door handle 2451 in Antique Black



DOOR AND GATE FURNITURE  
LEVER HANDLES



754

AB P  
A



1563

AB P  
A



2434

AB P  
A



2445

AB P  
A



2440

AB P  
A



2439

AB P  
A B

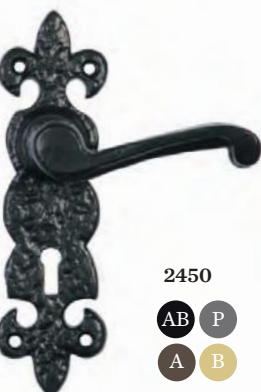

2450

AB P  
A B



2433

AB P  
A



879

AB P  
A

**754**  
Lock, latch, bathroom, Euro & oval  
228 x 50mm (9" x 2")

**2445**  
Lock, latch, bathroom, Euro & oval  
152 x 38mm (6" x 1 1/2")

**2450**  
Lock, latch, bathroom, Euro & oval  
190 x 57mm (7 1/2" x 2 1/4")

**1563**  
Lock, latch, bathroom, Euro & oval  
247 x 50mm (9 3/4" x 2")

**2440**  
Lock, latch, bathroom, Euro & oval  
152 x 38mm (6" x 1 1/2")

**2433**  
Latch only - 139 x 47mm (5 1/2" x 1 7/8")

**2434**  
Lock or latch - 184 x 57mm (7 1/4" x 2 1/4")  
Short latch - 143 x 57mm (5 5/8" x 2 1/4")

**2439**  
Lock or latch - 152 x 38mm (6" x 1 1/2")  
Short latch - 101 x 38mm (4" x 1 1/2")

**879**  
Latch only - 50mm (2")

*See glossary (p106) to identify which handle type you require. All products are spring loaded except where indicated.*



Lever door handle 2449  
in Antique Black



DOOR AND GATE FURNITURE  
LEVER HANDLES



2448  
AB P  
A



2442  
AB P  
A



2444  
AB P  
A



2496  
AB P  
A



2564  
SB P  
A



2491  
AB P  
A



2449  
AB P  
A



2451  
AB P  
A B



2454  
AB P  
A B



2495  
AB P  
A



2494  
AB P  
A



2563  
SB P  
A B



2520  
AB P  
A



2488  
AB P  
A



2519  
SB P  
A



2568  
SB P  
A



2456  
SB P  
A



2471  
AB P  
A

**2448**  
Lock, latch & bathroom  
159 x 50mm (6 1/4" x 2")

**2449**  
Lock, latch, bathroom, Euro & oval  
165 x 50mm (6 1/2" x 2")

**2520**  
Latch only - 108 x 50mm (4 1/4" x 2")

**2442**  
Lock, latch & bathroom  
159 x 50mm (6 1/4" x 2")

**2451**  
Lock, latch, bathroom, Euro & oval  
164 x 47mm (6 1/2" x 1 7/8")

**2488**  
Lock, latch, bathroom, Euro & oval  
127 x 50mm (5" x 2")

**2444**  
Lock, latch & bathroom  
165 x 50mm (6 1/2" x 2")

**2454**  
Lock, latch, bathroom, Euro & oval  
164 x 47mm (6 1/2" x 1 7/8")

**2519**  
Lock, latch & bathroom  
127 x 50mm (5" x 2")

**2496**  
Lock, latch, bathroom, Euro & oval  
177 x 38mm (7" x 1 1/2")

**2495**  
Lock, latch & bathroom  
184 x 50mm (6 1/2" x 2")

**2568**  
Lock, latch & bathroom  
152 x 38mm (6" x 1 1/2")

*See glossary (p106) to identify which handle type you require. All products are spring loaded except where indicated.*

**2564**  
Lock - 140 x 55mm (5 1/2" x 2 1/2")  
Latch - 114 x 55mm (4 1/2" x 2 1/2")

**2494**  
Lock, latch & bathroom  
152 x 50mm (6" x 2")

**2456**  
Lock, latch, bathroom, Euro & oval  
152 x 38mm (6" x 1 1/2")

**2491**  
Lock, latch, bathroom, Euro & oval  
197 x 45mm (7 3/4" x 1 3/4")

**2563**  
Lock - 140 x 38mm (5 1/2" x 1 1/2")  
Latch - 114 x 38mm (4 1/2" x 1 1/2")

**2471**  
Latch only - 50 x 50mm (2" x 2")





Lever door handle 2451  
in Antique Black

## DOOR AND GATE FURNITURE LEVER HANDLES

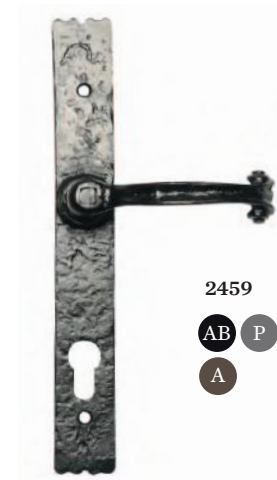

2459

AB P  
A



2460

AB P  
A



2461

AB P  
A



2463

AB P  
A



2462

AB P  
A



6054

AB P  
A



Cylinder 6000

### 2459

Lock, bathroom, Euro & oval  
266 x 38mm (10 1/2" x 1 1/2")  
72mm & 92mm standard centres  
Not spring loaded

### 2463

Lock or latch - 267 x 38mm (10 1/2" x 1 1/2")

### Cylinder 6000

Black double cylinder or thumb turn and single cylinder. Keyed alike, keyed to differ or master keyed. Odd sizes available in multiples of 5mm. Please ask for details.

### 2460

Lock, bathroom, Euro & oval  
266 x 38mm (10 1/2" x 1 1/2")  
72mm & 92mm standard centres  
Not spring loaded

### 2462

Lock, bathroom, Euro & oval  
273 x 44mm (10 3/4" x 1 3/4")  
72mm & 92mm standard centres  
Not spring loaded

### 2461

Lock, bathroom, Euro & oval  
266 x 38mm (10 1/2" x 1 1/2")  
72mm & 92mm standard centres  
Not spring loaded

### 6054

Lock, latch or Euro - 266 x 38mm  
72mm & 92mm standard centres  
(10 1/2" x 1 1/2")  
Not spring loaded

See glossary (p106) to identify which handle type you require



Door hinge front 814F in Antique Black  
and door hinge 814 in Argent



## DOOR AND GATE FURNITURE HINGES

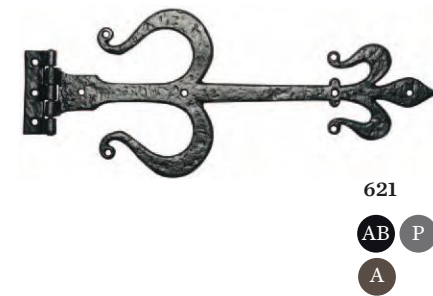
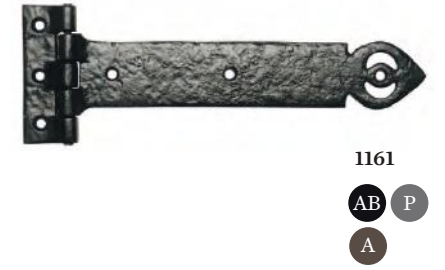

**799**  
228 x 101mm (9" x 4")  
304 x 140mm (12" x 5 1/2")  
400 x 146mm (15 3/4" x 5 3/4")  
457 x 152mm (18" x 6")  
533 x 152mm (21" x 6")  
609 x 160mm (24" x 6 1/4")

**3679**  
228 x 108mm (9" x 4 1/4")  
266 x 108mm (10 1/2" x 4 1/4")  
304 x 108mm (12" x 4 1/4")  
381 x 108mm (15" x 4 1/4")  
457 x 108mm (18" x 4 1/4")

**622**  
419 x 171mm (16 1/2" x 6 3/4")

**810**  
304 x 133mm (12" x 5 1/4")  
406 x 133mm (16" x 5 1/4")  
482 x 133mm (19" x 5 1/4")  
660 x 133mm (26" x 5 1/4")

**814**  
152 x 63mm (6" x 2 1/2")  
263 x 101mm (10 1/2" x 4")  
313 x 101mm (12" x 4")  
388 x 101mm (15" x 4")  
456 x 101mm (18" x 4")  
513 x 101mm (21" x 4")

**621**  
508 x 209mm (20" x 8 1/4")

**1161**  
304 x 101mm (12" x 4")  
381 x 101mm (15" x 4")  
457 x 101mm (18" x 4")

**1814**  
Lift off hinge  
Strap - 283mm (11")  
Plate - 88 x 28mm (3 1/2" x 1")

**1820**  
406 x 108mm (16" x 4 1/4")  
457 x 120mm (18" x 4 3/4")  
508 x 120mm (20" x 4 3/4")



# DOOR AND GATE FURNITURE HINGES



1159  
AB P  
A



809  
AB P  
A



645  
AB P  
A



1509  
AB P  
A



1120  
AB P  
A



1507  
AB P  
A

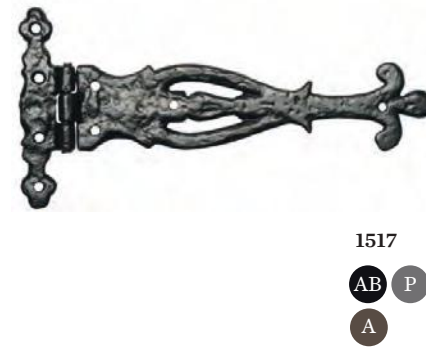

1517  
AB P  
A



1513  
AB P  
A



816  
AB P  
A



1508  
AB P  
A

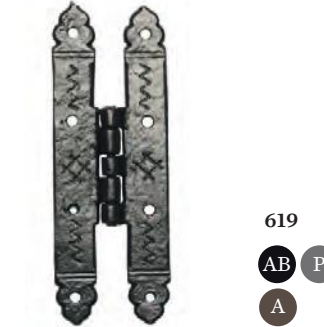

619  
AB P  
A



620  
AB P  
A



1512  
AB P  
A

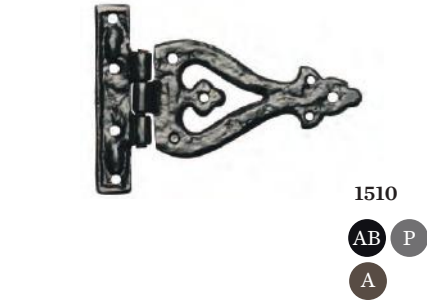

1510  
AB P  
A

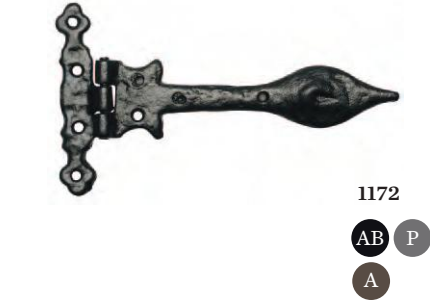

1172  
AB P  
A



1558  
AB P  
A



829  
AB P  
A



5141/5148  
SB P  
A

**1159**  
304 x 114mm (12" x 4 1/2")  
**1517**  
216 x 114mm (9" x 4 1/2")  
**1512**  
207 x 95mm (8" x 3 3/4")

**809**  
660 x 133mm (26" x 5 1/4")  
**1513**  
194 x 80mm (7 1/2" x 3 1/4")  
**1510**  
133 x 94mm (5 1/4" x 3 3/4")

**645**  
457 x 101mm (18" x 4")  
609 x 101mm (24" x 4")  
**816**  
203 x 95mm (8" x 4")  
**1172**  
156 x 88mm (6" x 3 1/2")  
232 x 114mm (9" x 4 1/2")  
304 x 114mm (12" x 4 1/2")

**1509**  
Suitable for cabinet doors  
111 x 51mm (4 1/2" x 2")  
**1508**  
Suitable for cabinet doors  
95 x 45mm (3 1/4" x 1 3/4")  
**1558**  
Suitable for cabinet doors  
101 x 35mm (4" x 1 3/8")

**1120**  
Suitable for cabinet doors  
89 x 41mm (3 1/2" x 1 5/8")  
**619**  
171 x 63mm (6 3/4" x 2 1/2")  
**829**  
Suitable for cabinet doors  
90 x 69mm (3 1/2" x 2 5/8")

**1507**  
Suitable for cabinet doors  
80 x 42mm (3 1/4" x 1 5/8")  
**620**  
177 x 63mm (7" x 2 1/2")  
**5141/5148**  
(5141) Steel butt hinge – 102mm (4")  
(5148) Steel butt hinge – 76mm (3")



# DOOR AND GATE FURNITURE

## HINGES AND HINGE FRONTS



925  
AB P  
A



927  
AB P  
A



926  
AB P  
A B



798  
AB P  
A B



797  
AB P  
A



977  
AB P  
A



1511  
AB P  
A



978  
AB P  
A



820  
AB P  
A



821  
AB P  
A



817  
AB P  
A



819  
AB P  
A



641  
AB P  
A



814F  
AB P  
A

**925**  
Suitable for cabinet doors  
51 x 38mm (2 1/8" x 1 3/4")  
70 x 50mm (2 3/4" x 2")

**1511**  
139 x 114mm (5 1/2" x 4 1/2")

**819**  
Hinge front  
304 x 129mm (12" x 5 3/4")  
381 x 146mm (15" x 5 3/4")  
457 x 146mm (18" x 5 3/4")  
533 x 146mm (21" x 5 3/4")

**927**  
Suitable for cabinet doors  
130 x 73mm (5" x 2 7/8")

**978**  
Hinge front  
101 x 89mm (4" x 3 1/2")

**641**  
Hinge front  
345 x 90mm (13 3/4" x 3 1/2")

**926**  
Suitable for cabinet doors  
83 x 45mm (3 1/4" x 1 3/4")

**820**  
Hinge front  
152 x 41mm (6" x 1 5/8")  
304 x 63mm (12" x 2 1/2")  
406 x 120mm (16" x 4 3/4")  
457 x 120mm (18" x 4 3/4")

**814F**  
Hinge front  
304mm (12"), 381mm (15")  
457mm (18"), 533mm (21")

**798**  
Hinge front  
304 x 139mm (12" x 5 1/2")  
392 x 145mm (15 1/2" x 5 3/4")  
457 x 152mm (18" x 6")  
533 x 152mm (21" x 6")

**821**  
Hinge front  
203 x 73mm (8" x 1 7/8")  
304 x 89mm (12" x 3 1/2")  
457 x 139mm (18" x 5 1/2")

**797**  
Hinge front  
381 x 82mm (15" x 3 1/4")  
457 x 89mm (18" x 3 1/2")

**817**  
Hinge front  
406 x 165mm (16" x 6 1/2")  
406 x 159mm (16" x 6 1/4")  
508 x 216mm (20" x 8 1/2")

**977**  
Hinge front  
247 x 54mm (9 3/4" x 2 1/8")



# DOOR AND GATE FURNITURE

## THUMB LATCHES



3624  
AB P  
A



671  
AB P  
A



1145  
AB P  
A

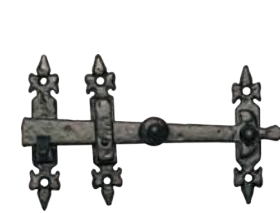

3618  
AB P  
A

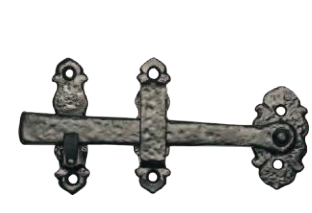

688  
AB P  
A



3619  
AB P  
A B



1147  
AB P  
A



1124  
AB P  
A



3630  
AB P  
A



**3624**  
Handle - 203mm (8")  
Latch - 216mm (8 1/2")  
Handle - 235mm (9 1/4")  
Latch - 216mm (8 1/2")  
Available in left and right hand versions

**3618**  
Handle - 228 x 63mm (9" x 2 1/2")  
Latch - 197mm (7 3/4")

**1147**  
Handle - 197mm (7 3/4")  
Latch - 152mm (6")

**671**  
Handle - 254 x 63mm (10" x 2 1/2")  
Latch - 228mm (9")  
Available in left and right hand versions

**688**  
Handle - 254 x 50mm (10" x 2")  
Latch - 177mm (7")

**1124**  
Side fixing catch  
Handle - 190 x 50mm (7 1/2" x 2")  
Latch - 101mm (4")

**1145**  
Handle - 177 x 38mm (7" x 1 1/2")  
Latch - 216mm (8 1/2")

**3619**  
Handle - 203 x 63mm (8" x 2 1/2")  
Latch - 127mm (5")

**3630**  
Handle - 190 x 63mm (7 1/2" x 2 1/2")  
Latch - 152mm (6")



DOOR AND GATE FURNITURE  
THUMB LATCHES



3623  
AB P  
A

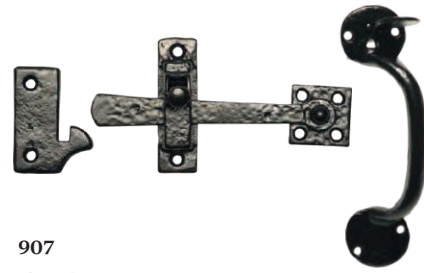

907  
AB P  
A



3625  
AB P  
A



3628  
AB P  
A



3613  
AB P  
A B

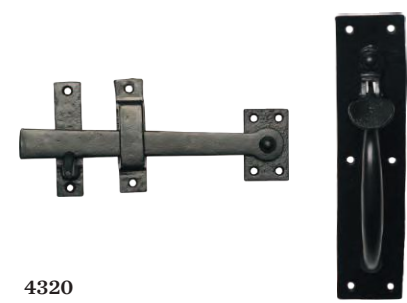

4320  
SB P  
A



3620  
AB P  
A



3614  
AB P  
A

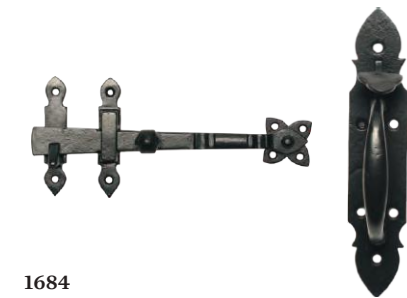

1684  
SB P  
A B



3622  
SB P  
A



1681  
SB P  
A

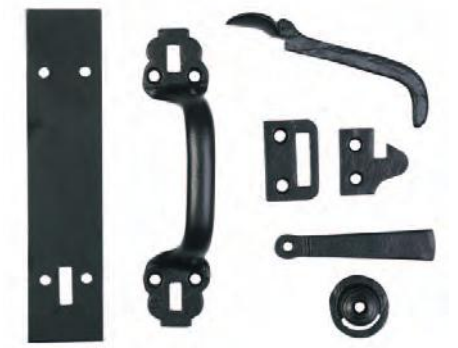

4305  
SB P  
A



Reverse of latch set 3619 in Argent

**3623**  
Handle - 203mm (8")  
Latch - 152mm (6")

**3628**  
Handle - 260 x 73mm (10 1/4" x 2 7/8")  
Latch - 247mm (9 3/4")

**3620**  
Cupboard latch - 127mm (5")

**907**  
Cranked handle - 190mm (7 1/2")  
Latch - 139mm (5 1/2")  
Available in left and right hand versions

**3613**  
Handle - 152mm (6")  
Latch - 114mm (4 1/2")

**3614**  
Cupboard latch - 114mm (4.5")

**3625**  
Bow handles each side of door  
Handle - 241mm (9 1/2")  
Latch - 203mm (8")

**4320**  
Plate - 247 x 59mm (9 3/4" x 2 1/4")  
Latch - 228mm (9")  
Inside of handle - 108mm (4 1/4")

**1684**  
Plate - 216 x 44mm (8 1/2" x 1 3/4")  
Latch - 241mm (9 1/2")  
Inside of handle - 89mm (3 1/2")

**3622**  
Plate - 191 x 35mm (7 1/2" x 1 3/8")  
Latch - 203mm (8")  
Inside of handle - 89mm (3 1/2")

**1681**  
Cranked or straight. Cranked has locking wedge. Available in left and right hand versions. Handle - 191mm (7 1/2")  
Latch - 127mm (5")

**4305**  
Plate - 197 x 46mm (7 3/4" x 1 3/4")  
Inside of handle - 89mm (3 1/2")

See glossary (p106) to understand the difference between straight and cranked



DOOR AND GATE FURNITURE  
GATE LATCHES



717  
AB P  
A



632  
AB P  
A



911  
AB P  
A



679  
AB P  
A



491  
SB P  
A



3431  
SB P  
A



3981  
SB P  
A



1248  
AB P  
A



1251  
AB P  
A



1249  
AB P  
A



3979  
SB P  
A



1146  
AB P  
A



1246  
AB P  
A



4438  
SB P  
A

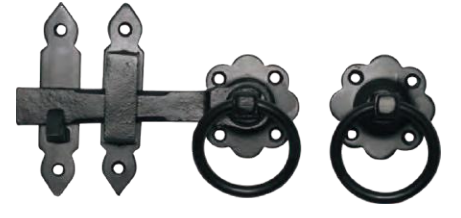

3258  
SB P  
A



869  
AB P  
A



866  
AB P  
A



4088  
SB P  
A



867  
SB P  
A

**717**  
Plate - 127 x 76mm (5" x 3")  
Handle diameter - 89mm (3 1/2")  
**679**  
Handle - 76mm (3")  
Rose - 63mm (2 1/2")  
**3981**  
Ring - 76mm (3")  
Plate - 76mm (3")

**632**  
Handle - 101mm (4")  
Rose diameter - 101mm (4")  
**491**  
Plate - 108mm (4 1/4")  
Ring - 76mm (3")  
**1248**  
Latch - 203mm (8") or 254mm (10")

**911**  
Handle - 76mm (3")  
Rose - 50mm (2")  
**3431**  
Ring - 76mm (3")  
Plate - 76mm (3")  
**1251**  
Latch - 127mm (5") or 177mm (7")

**1249**  
Latch - 152mm (6")\*, 177mm (7")\*,  
203mm (8"), 254mm (10")  
\*Supplied with 1146 catch & staple  
**1246**  
Latch - 152mm (6") or 197mm (7 3/4")  
**869**  
Latch - 203mm (8")

**3979**  
Latch - 127mm (5"), 152mm (6"), 177mm (7")  
**4438**  
Latch - 152mm (6")  
**866**  
Latch - 177mm (7") or 203mm (8")  
**4088**  
Latch - 152mm (6")

**1146**  
Latch - 127mm (5")  
**3258**  
Latch - 127mm (5"), 152mm (6"), 177mm (7")  
**867**  
Latch - 152mm (6")



Lever door handle 2449  
and letter plate 1073  
both in Antique Black



## DOOR AND GATE FURNITURE LETTER PLATES



1073

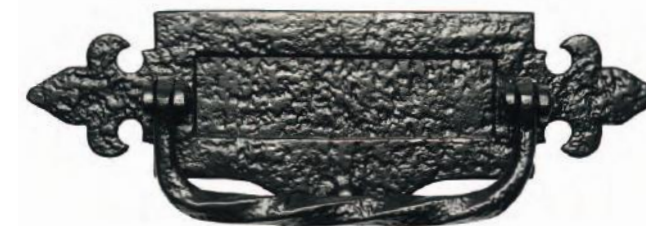

1085

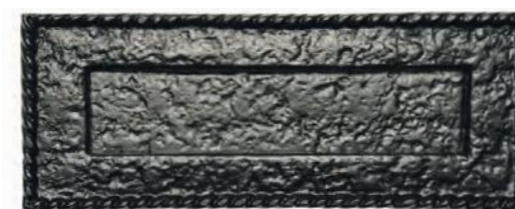

1324



962



1911



1083



	Outside	Opening	Fixing bolt centres
<b>1073</b>			
Size 1	304 x 82mm (12" x 3")	144 x 38mm (6" x 1 1/2")	222mm (8 1/2")
Size 2	362 x 88mm (14 1/4" x 3 1/2")	203 x 44mm (8" x 1 3/4")	277mm (10 3/4")
Size 3	419 x 76mm (16 1/2" x 3")	260 x 33mm (10 1/4" x 1 5/16")	345mm (13 1/2")

	Outside	Opening	Fixing bolt centres
<b>1324</b>			
Size 1	228 x 76mm (9" x 3")	155 x 41mm (6 1/8" x 1 5/8")	191mm (7 1/2")
Size 2	267 x 101mm (10 1/2" x 4")	203 x 45mm (8" x 1 3/4")	235mm (9 1/4")

	Outside	Opening	Fixing bolt centres
<b>1911</b>			
Size 1	267 x 114mm (10 1/2" x 4 1/2")	203 x 41mm (8" x 1 5/8")	235mm (9 1/4")

	Outside	Opening	Fixing bolt centres
<b>1085</b>			
Size 1	304 x 101mm (12" x 4")	139 x 38mm (5 1/2" x 1 1/2")	222mm (8 3/4")
Size 2	362 x 104mm (14 1/4" x 4 1/8")	203 x 44mm (8" x 1 3/4")	279mm (11")

	Outside	Opening	Fixing bolt centres
<b>962</b>			
Size 1	228 x 101mm (9" x 4")	163 x 41mm (6 3/4" x 1 5/8")	203mm (8")

	Outside	Opening	Fixing bolt centres
<b>1083</b>			
Size 1	266 x 76mm (8" x 3")	139 x 35mm (5 1/2" x 1 1/3")	171mm (6 3/4")
Size 2	266 x 108mm (10 1/2" x 4 1/2")	203 x 44mm (8" x 1 3/4")	241mm (9 1/4")
Size 3	340 x 102mm (13 3/4" x 4")	238 x 50mm (9 3/4" x 1 8")	296mm (11 1/2")
Size 4	352 x 127mm (13 3/4" x 5")	275 x 62mm (11 x 2 1/2")	313mm (12 1/2")



# DOOR AND GATE FURNITURE LETTER PLATES



1963

AB P  
A



967

AB P  
A



1233

AB P  
A



1100/1102/1103

AB P  
A B

Product	Outside	Opening	Fixing bolt centres
1963	295 x 108mm (11 5/8" x 4 1/4")	203 x 44mm (8" x 1 3/4")	254mm (10")
1100	Internal flap - 241 x 71mm (9 1/2" x 3")		
1102	Internal flap - 292 x 76mm (11 1/2" x 3")		
1103	Internal flap - 355 x 101mm (14" x 4")		

Product	Outside	Opening
967	317 x 76mm (13" x 3")	139 x 38mm (5 1/2" x 1 1/2")
1233	Outside 311 x 57mm (12 1/4" x 2 1/4")	Opening 133 x 28mm (5 1/4" x 1 1/8")

# DOOR AND GATE FURNITURE BOLTS AND LOCKS



1155

AB P  
A B



1156

AB P  
A



1157

AB P  
A B



1131

AB P  
A B

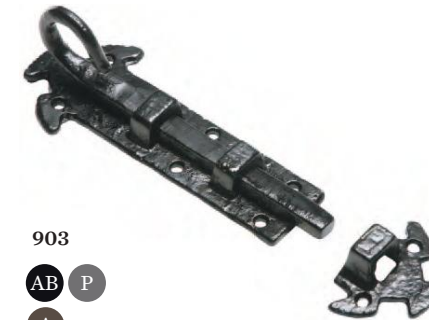

903

AB P  
A



1196

AB P  
A



902

AB P  
A



830

AB P  
A



1149

AB P  
A

1155	Straight or cranked Plate - 152 x 45mm (6" x 1 3/4") or 203 x 54mm (8" x 2 1/8")
	Straight only Plate - 254 x 54mm (10" x 2 1/8") or 304 x 54mm (12" x 2 1/8")
1131	Straight or cranked Plate - 101 x 25mm (4" x 1")
902	Straight only Plate - 127 x 50mm (5" x 2") Bolt - 152mm (6")

1156	Straight or cranked Plate - 152 x 45mm (6" x 1 3/4") or 203 x 45mm (8" x 1 3/4")
903	Straight only Plate - 152 x 63mm (6" x 2 1/2") Bolt - 152mm (6") Plate - 222 x 89mm (8 3/4" x 3 1/2") Bolt - 228mm (9")
830	Straight or cranked Bolt - 101mm (4") or 152mm (6")

1157	Straight or cranked Plate - 114 x 38mm (4 1/2" x 1 1/2") Bolt - 127mm (5") Plate - 190 x 57mm (7 1/2" x 2 1/4") Bolt - 203mm (8")
	Straight only Plate - 241 x 57mm (9 1/2" x 2 1/4") Bolt - 254mm (10") Plate - 292 x 57mm (11 1/2" x 2 1/4") Bolt - 304mm (12")
1196	Bolt - 35mm (2 1/2" x 1 3/8")
1149	Plate - 304 x 50mm (12" x 2") Bolt - 555mm (22")

See glossary (p106) to understand the difference between straight and cranked



# DOOR AND GATE FURNITURE

## BOLTS AND LOCKS



**812**  
Straight or cranked  
Plate - 193 x 50mm (7 5/8" x 2")  
Bolt - 203mm (8")

Straight only  
Plate - 228 x 54mm (9" x 2 1/8")  
Bolt - 254mm (10")  
Plate - 279 x 57mm (11" x 2 1/4")  
Bolt - 304mm (12")

**1546**  
Straight only  
Plate - 101mm (4")

**5170**  
Straight only  
Bolt - 152 x 45mm (6" x 1 3/4")

See glossary (p106) to understand the difference between straight and cranked

**1257**  
Straight only  
Plate - 190 x 57mm (7 1/2" x 2 1/4")  
Bolt - 203mm (8")

Straight only  
Plate - 241 x 57mm (9 1/2" x 2 1/4")  
Bolt - 254mm (10")  
Plate - 292 x 57mm (11 1/2" x 2 1/4")  
Bolt - 304mm (12")

**1547**  
Cranked only  
Plate - 101mm (4")

**4321**  
Straight or cranked  
152 x 45mm (6" x 1 3/4")

**1154**  
Straight only  
Plate 101 x 38mm (4" x 1 1/2")  
or 152 x 38mm (6" x 1 1/2")

**4090**  
Straight only. Plate width for all - 50mm (2")  
305 x 16mm (12" x 5/8"), 381 x 16mm (15" x 5/8"), 457 x 16mm (18" x 5/8"), 533 x 16mm (21" x 5/8"), 610 x 16mm (24" x 5/8"), 762 x 19mm (30" x 3/4"), 915 x 19mm (36" x 3/4"), 1,220 x 19mm (48" x 3/4")

**796**  
Straight only  
Plate width for all - 57mm (2 1/4")  
203mm (8"), 254mm (10"), 305mm (12")  
381mm (15"), 457mm (18"), 533mm (21")  
610mm (24"), 686mm (27"), 762mm (30")  
915mm (36")



Bolt 1155 in Antique Black



# DOOR AND GATE FURNITURE

## BOLTS AND LOCKS



Door chain 2968 in Antique Black and Night latch 5144 in Smooth Black



1158  
AB P  
A

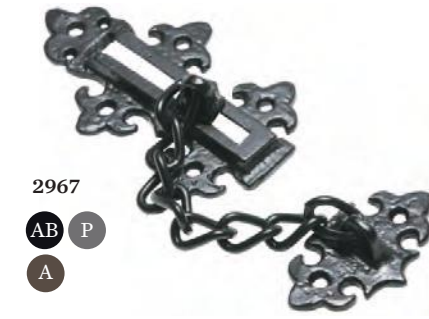

2967  
AB P  
A



5135  
AB P  
A



2968  
AB P  
A



1150  
AB P  
A B



4091  
AB P  
A



S520  
AB P  
A



1204  
AB P  
A



5147  
SB P  
A

**1158**  
Flush bolt - 152 x 25mm (6" x 1")  
or 203 x 25mm (8" x 1")

**2968**  
152mm (6")

**S520**  
Rim lock - 152 x 102mm (6" x 4")

**2967**  
123 x 76mm (4 3/4" x 3")

**1150**  
Privacy bolt with vacant/engaged sign  
Latch - 64 x 25mm (2 1/2" x 1")  
Catch - 64 x 20mm (2 1/2" x 3/4")  
Disc - 70 x 70mm (2 3/4" x 2 3/4")

**1204**  
Lock, latch or deadlock. Supplied with 1550  
knob, oval escutcheon and Wilkes spindle.  
Lock body - 125 x 103 x 19mm  
(4 3/4" x 4" x 3/4")

**5135**  
Espagnolette bolt - 2.4m (8ft)  
Also available in 3.05m (10ft) on request  
Secures the door both top and bottom.

**4091**  
Drop bolt - 457 x 101mm (18" x 4")  
Diameter of handle 15mm (5/8")  
Guides 86 x 45mm (3 3/8" x 1 3/4") &  
66 x 45mm (2 1/2" x 1 3/4")

**5147**  
Door rack bolt



# DOOR AND GATE FURNITURE

## BOLTS AND LOCKS



5144  
SB

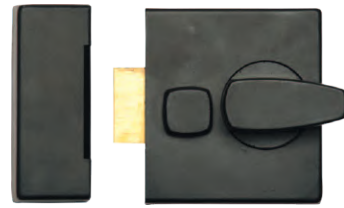

5143  
SB



5142  
SB



5132  
SB P  
A



5133  
SB P  
A



7006/7007



7005



7000/7001

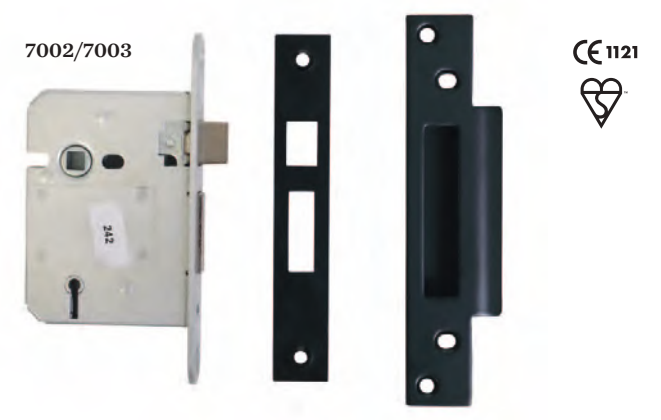

7002/7003



7004

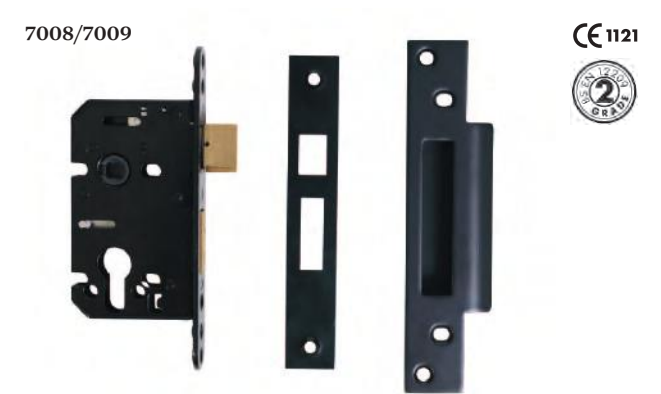

7008/7009

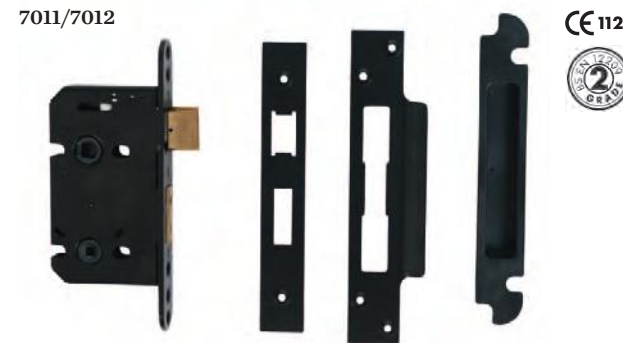

7011/7012

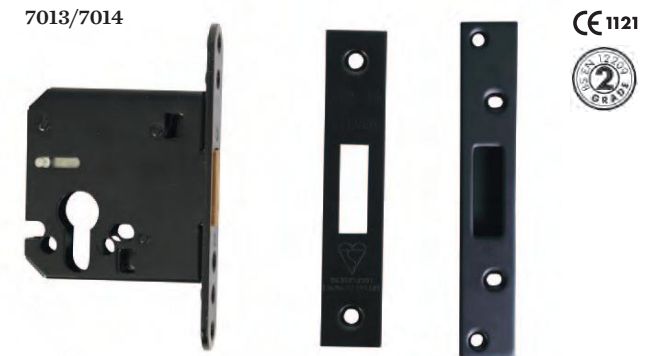

7013/7014



**5144**  
Standard night latch – 60mm (2 3/8")

**5143**  
Narrow night latch – 40mm (1 1/2")

**5142**  
Rim cylinder and keys – 33mm (1 1/4")

**5132**  
Star spindle knob (Chubb) – 33mm (1 3/10")

**5133**  
Bathroom turn and release – 33mm (1 3/10")  
Suitable dead bolt available (5140)

**7005**  
Deadlock rebate kit

**7006/7007**  
(7006) Tubular latch – 64mm (2 1/2")  
(7007) Tubular latch – 76mm (3")

**7000/7001**  
(7000) Deadlock with escutcheons – 64mm (2 1/2")  
(7001) Deadlock with escutcheons – 76mm (3")

**7004**  
Sash rebate kit

**7002/7003**  
(7002) Sashlock – 64mm (2 1/2")  
(7003) Sashlock – 76mm (3")

**7008/7009**  
(7008) Euro sashlock – 64mm (2 1/2")  
(7009) Euro sashlock – 76mm (3")

**7011/7012**  
(7011) Bathroom lock – 64mm (2 1/2")  
(7012) Bathroom lock – 76mm (3")

**7013/7014**  
(7013) Euro deadlock – 64mm (2 1/2")  
(7014) Euro deadlock – 76mm (3")



# DOOR AND GATE FURNITURE

## PULL HANDLES



2157  
AB P  
A



2155  
AB P  
A



2173  
AB P  
A



2167  
AB P  
A



2164  
AB P  
A



807  
AB P  
A



2172  
AB P  
A



3603  
AB P  
A B

**2157**  
304 x 63mm (12" x 2 1/2")  
Inside grip - 152mm (6")

**2164**  
Straight handle  
381 x 50mm (15" x 2")

**2155**  
343 x 73mm (13 1/2" x 2 7/8")  
Inside grip - 152mm (6")

**807**  
152 x 44mm (6" x 1 3/4")  
266 x 57mm (10 1/2" x 2 1/4")

**2173**  
444 x 76mm (17 1/2" x 3")  
Inside grip - 190mm (7 1/2")

**2172**  
266 x 44mm (10 1/2" x 1 3/4")

**2167**  
386 x 50mm (15 1/4" x 2")

**3603**  
191 x 64mm (7 1/2" x 2 1/2")



DOOR AND GATE FURNITURE  
PULL HANDLES



564

AB P  
A B



937

AB P  
A



1579

AB P  
A



1125

AB P  
A



1578

AB P  
A



3652

AB P  
A



3651

SB P  
A



2788

SB P  
A



2105

SB P  
A



1883

SB P  
A



4013

SB P  
A



Pull handles 564  
in Antique Black

**564**  
101mm (4"), 127mm (5"),  
152mm (6"), 177mm (7"),  
228mm (9")  
**1578**  
215 x 63mm (8 1/2" x 2 1/2")

**937**  
127mm (5")  
**3652**  
254mm (10")

**1579**  
152mm (6")  
**3651**  
203mm (8") or 254mm (10")

**1125**  
146mm (5 3/4")  
**2788**  
Inside grip - 76mm (3")  
or 101mm (4")

**2105**  
114mm (4 1/2")

**1883**  
Inside grip - 76mm (3"),  
89mm (3 1/2"), 101mm (4"),  
127mm (5"), 152mm (6")

**4013**  
152mm (6"), 190mm (7 1/2"),  
254mm (10")





Push plate 769 and door knob 1550 in Argent

## DOOR AND GATE FURNITURE DOOR KNOBS

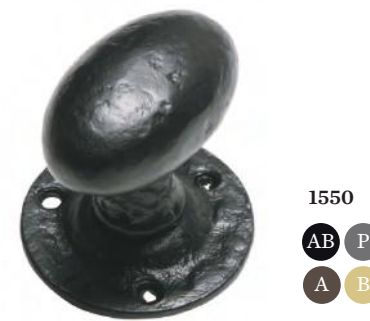

**808**  
Mortice or rim  
Knob - 50mm (2")  
Plate - 63mm (2 1/2")

**1205**  
Mortice or rim  
Knob - 50mm (2")  
Plate - 85mm (3 3/8")

**1550**  
Mortice or rim  
Knob - 63 x 39mm (2 1/2" x 1 1/2")  
Plate - 57mm (2 1/4")

**1069**  
Mortice or rim  
Knob - 44mm (1 3/4")  
Plate - 67 x 50mm (2 5/8" x 2")

**1206**  
Mortice or rim  
Knob - 50mm (2")  
Plate - 60mm (2 3/8")

**1551**  
Mortice or rim  
Knob - 63 x 38mm (2 1/2" x 1 1/2")  
Plate - 67 x 50mm (2 5/8" x 2")

**1089**  
Mortice or rim  
Knob - 60 x 38mm (2 3/8" x 1 1/2")  
Plate - 67 x 50mm (2 5/8" x 2")

**1207**  
Mortice or rim  
Knob - 50mm (2")  
Plate - 85mm (3 3/8")

**3067**  
Mortice or rim  
Knob - 44mm (1 3/4")  
Plate - 60mm (2 1/4")

See glossary (p106) to understand the difference between mortice and rim



DOOR AND GATE FURNITURE  
DOOR KNOBS



3056  
AB P  
A B



3064  
AB P  
A B



1203  
AB P  
A



1554  
AB P  
A



C387  
SB P  
A



4085  
SB P  
A



4064  
SB P  
A



3372  
SB P  
A



1553  
AB P  
A



3075  
SB P  
A



3370  
SB P  
A



3072  
SB P  
A



3066  
SB P  
A

**3056**  
Mortice or rim  
Knob - 57mm (2 1/4")  
Plate - 63mm (2 1/2")  
Knob - 70mm (2 3/4")  
Plate - 76mm (3")

**4085**  
Mortice or rim  
Knob - 41mm (1 5/8")  
Plate - 64mm (2 1/2")

**3370**  
Centre door knob  
Knob - 73mm (2 7/8")  
Plate - 76mm (3")

**3064**  
Centre door knob  
Knob - 70mm (2 3/4")  
Plate - 76mm (3")

**4064**  
Mortice or rim  
Knob - 64 x 38mm (2 1/2" x 1 1/2")  
Round plate - 64mm (2 1/2")

**3072**  
Centre door knob  
Knob - 82mm (3 1/4")  
Plate - 171 x 120mm (6 3/4" x 4 3/4")

**1203**  
Mortice or rim  
Knob - 50mm (2")  
Plate - 67 x 50mm (2 5/8" x 2")

**3372**  
Centre door knob  
Knob - 82mm (3 1/4")  
Plate - 171 x 120mm (6 3/4" x 4 3/4")

**3066**  
Centre door knob  
Knob - 82mm (3 1/4")  
Plate diameter - 101mm (4")

**1554**  
Mortice or rim (Mortice shown)  
Knob - 44mm (1 3/4")  
Plate - 66 x 50mm (2 5/8" x 2")

**1553**  
Mortice or rim (Mortice shown)  
Knob - 60 x 38mm (2 3/8" x 1 1/2")  
Plate - 66 x 50mm (2 5/8" x 2")

**C387**  
Mortice or rim (Mortice shown)  
Ball - 44mm (1 3/4")

**3075**  
Mortice or rim (Rim shown)  
Square design with smooth finish  
Knob - 64 x 38mm (2 1/2" x 1 1/2")  
Plate - 64 x 64mm (2 1/2" x 2 1/2")  
Escutcheon - 38mm (1 1/2")

See glossary (p106) to understand the difference between mortice and rim



DOOR AND GATE FURNITURE  
DOOR KNOCKERS

578  
AB P  
A



896  
AB P  
A



4896  
AB P  
A B



1239  
AB P  
A



574  
AB P  
A



1117  
AB P  
A



586  
AB P  
A



782  
AB P  
A



846  
AB P  
A



**578**  
197 x 114mm (7 3/4" x 4 1/2")  
**1239**  
Hand - 165 x 70mm (6 1/2" x 2 3/4")  
**586**  
140 x 101mm (5 1/2" x 4")

Lion head - 123 x 76mm (4 3/4" x 3")  
Ring - 101mm (4")  
**574**  
Fox - 127 x 127mm (5" x 5")  
**782**  
Ring - 101mm (4")  
Plate - 50mm (2")

**4896**  
Lion head - 114 x 95mm (4 1/2" x 3 3/4")  
Ring - 101mm (4")  
**1117**  
Plate - 101 x 50mm (4" x 2")  
**846**  
Ring - 127mm (5")  
Plate - 69mm (2 3/4")



Lion head door knocker 4896 in Brass



DOOR AND GATE FURNITURE  
DOOR KNOCKERS



1197  
AB P  
A



571  
AB P  
A



944  
AB P  
A



832  
AB P  
A



1005  
SB P  
A



2618  
AB P  
A



2621  
AB P  
A B



2623  
AB P  
A

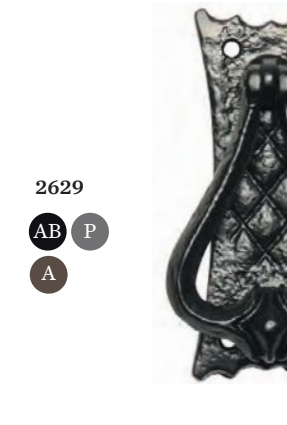

2629  
AB P  
A



2630  
AB P  
A

**1197**  
Plate - 228 x 120mm (9" x 4 3/4")  
**1005**  
203 x 70mm (8" x 2 3/4")  
**2623**  
Owl bedroom door knocker  
101 x 38mm (4" x 1 1/2")

**571**  
German 16th century 'Dolphin' pattern  
203 x 50mm (8" x 2")  
**944**  
Plate - 190 x 83mm (7 1/2" x 3 1/4")  
**2618**  
Laughing cat bedroom door knocker  
108 x 31mm (4 1/4" x 1 1/4")  
**2629**  
Bedroom door knocker  
127 x 50mm (5" x 2")

**832**  
242 x 57mm (9 1/2" x 2 1/4")  
**2621**  
Bat bedroom door knocker  
76 x 89mm (3" x 3 1/2")  
**2630**  
Lion bedroom door knocker  
133 x 79mm (5 1/4" x 3 1/8")





# DOOR AND GATE FURNITURE

## DOOR ACCESSORIES



House numerals 1979, cylinder latch cover 1486 and mortice door knob fixed as a centre door knob 1550, all in Antique Black

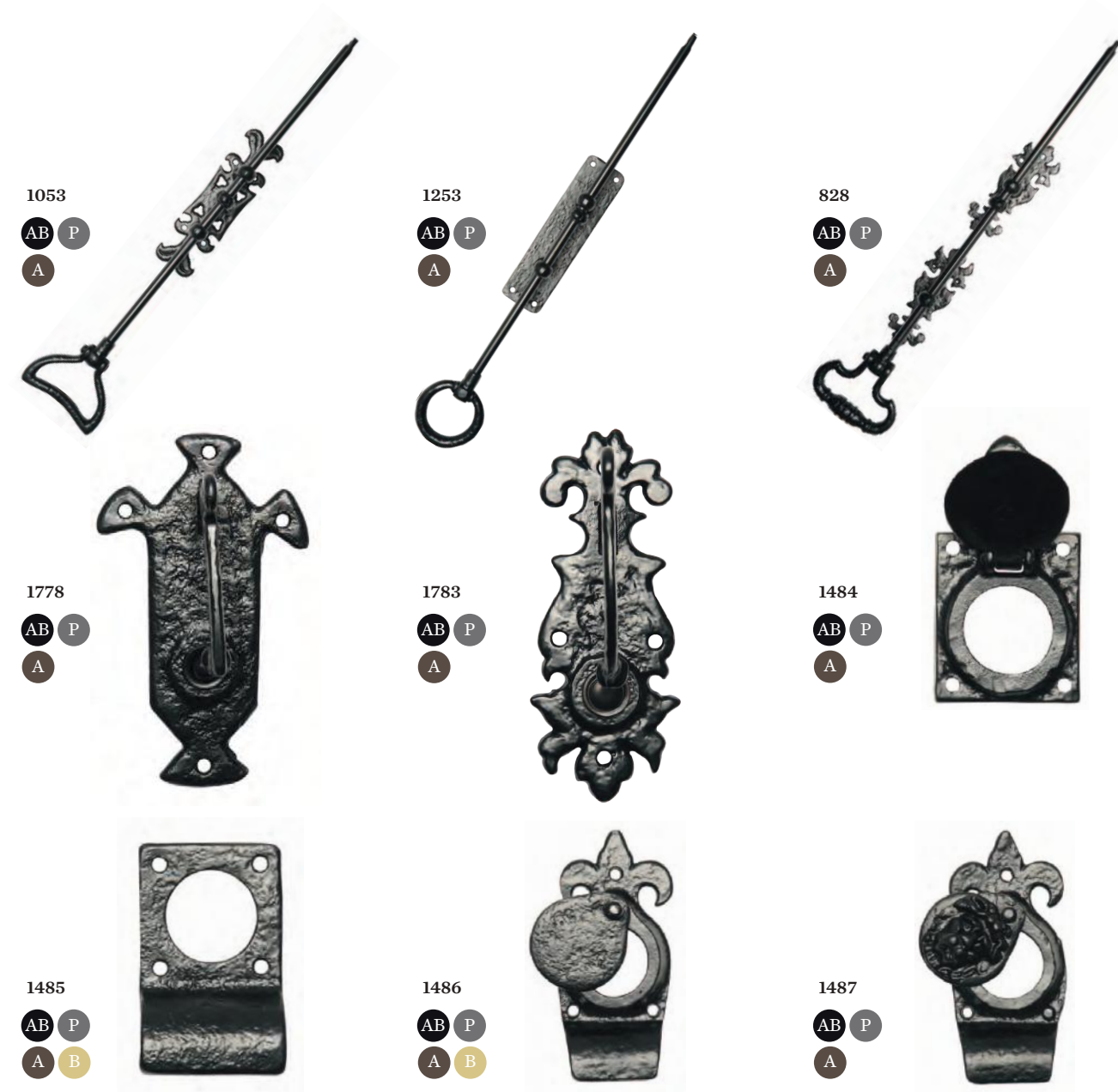

- 1053**  
Bell pull – 521mm (20 1/2")  
Suitable for use with bell crank
- 1253**  
Bell pull – 508mm (20")  
Suitable for use with bell crank
- 828**  
Bell pull – 521mm (20 1/2")  
Suitable for use with bell crank
- 1778**  
Bell crank – 152 x 89mm (6" x 3 1/2")  
Available fitted for use with electric bell or not fitted for traditional bell
- 1783**  
Bell crank – 139 x 50mm (5 1/2" x 2")  
Available fitted for use with electric bell or not fitted for traditional bell
- 1485**  
Cylinder latch pull  
85 x 50mm (3 1/2" x 2")
- 1486**  
Cylinder latch cover/pull  
127 x 58mm (5" x 2 1/2")
- 1487**  
Cylinder latch cover/pull  
127 x 58mm (5" x 2 1/2")
- 1484**  
Cylinder latch cover  
65 x 58mm (2 1/2" x 2 1/4")



DOOR AND GATE FURNITURE  
DOOR ACCESSORIES



853  
AB P  
A



1498  
AB P  
A



1488  
AB P  
A

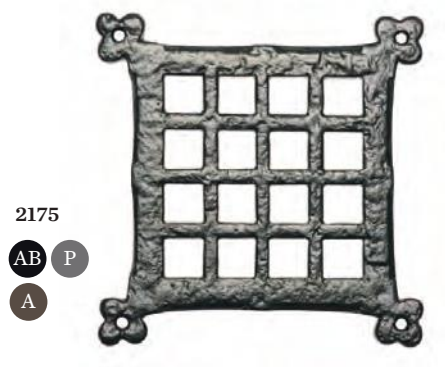

2175  
AB P  
A

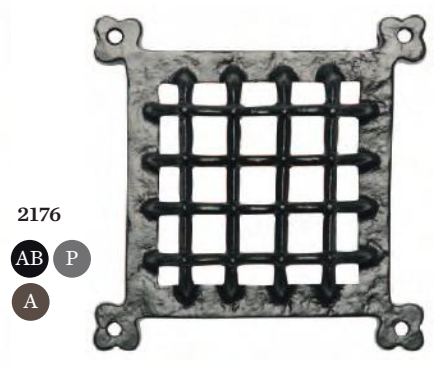

2176  
AB P  
A



1190  
AB P  
A



1756  
AB P  
A



4748  
AB P  
A



1753  
AB P  
A



1081  
AB P  
A B



153  
AB P  
A B



1502  
AB P  
A B



1761  
AB P  
A B



751  
AB P  
A

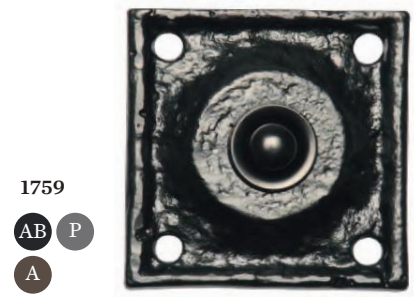

1759  
AB P  
A



1490  
AB P  
A



1503  
AB P  
A



1065  
AB P  
A B

**853**  
Cylinder latch knocker  
197 x 57mm (7 3/4" x 2 1/4")

**1756**  
Bell push - 85 x 85mm (3 1/4" x 3 1/4")  
Supplied with electrical contacts

**1761**  
Bell push - 121 x 32mm (4 3/4" x 1 1/4")  
Supplied with electrical contacts

**1498**  
Cylinder latch cover  
58 x 58mm (2 5/16" x 2 5/16")

**4748**  
Bell push - 77 x 44mm (3" x 1 3/4")  
Supplied with electrical contacts

**751**  
Bell push - 57 x 57mm (2 1/4" x 2 1/4")  
Supplied with electrical contacts

**1488**  
Euro cylinder latch pull  
Backplate - 85 x 50mm (3 3/8" x 2")  
Projection - 20mm (3/4")  
To be used with a Euro profile cylinder

**1753**  
Bell push - 89 x 44mm (3 1/2" x 1 3/4")  
Supplied with electrical contacts

**1759**  
Bell push - 60 x 60mm (2 3/8" x 2 3/8")  
Supplied with electrical contacts

**2175**  
Square door grille - 171 x 171mm (6 3/4")

**1081**  
Door stud. Drive or screw  
Head - 16mm (5/8"), 19mm (3/4"),  
22mm (7/8"), 25mm (1")

**1490**  
Escutcheon - 44 x 30mm (1 3/4" x 1 1/8")

**2176**  
Square door grille  
165 x 165mm (6 1/2") or 304 x 304mm (12")

**153**  
Door stud. Screw  
Head - 22mm (7/8")

**1503**  
Escutcheon - 48 x 35mm (1 7/8" x 1 3/8")

**1190**  
Escutcheon - 48 x 25mm (1 7/8" x 1")

**1502**  
Escutcheon - 45 x 30mm (1 3/4" x 1 1/8")

**1065**  
Escutcheon - 54 x 25mm (2 1/8" x 1")



DOOR AND GATE FURNITURE  
DOOR ACCESSORIES



1504  
AB P  
A



3012  
SB P  
A

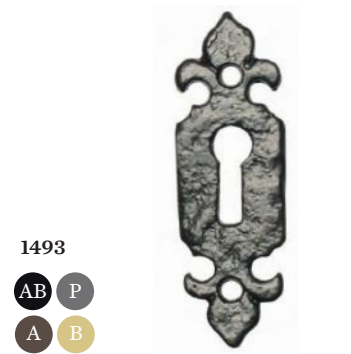

1493  
AB P  
A B



1977  
AB P  
A



1855



3011  
AB P  
A



1401  
AB P  
A B



1400  
AB P  
A



1976  
AB P  
A



777



3045  
SB P  
A



5136  
SB P  
A



Cylinder 6000



1979  
AB P  
A B

**1504**  
Escutcheon – 50 x 38mm (2" x 1 1/2")  
**3011**  
Escutcheon – 44 x 32mm (1 3/4" x 1 1/4")  
**3045**  
Escutcheon – 50mm (2")

**3012**  
Steel escutcheon – 48mm (1 7/8")  
**1401**  
Escutcheon with Euro profile  
50 x 50mm (2" x 2")  
**5136**  
Door stop – 89mm (3 1/2")

**1493**  
Escutcheon – 73 x 25mm (2 7/8" x 1")  
**1400**  
Escutcheon with Euro profile  
70 x 50mm (2 3/4" x 2")  
**Cylinder 6000**  
Black double cylinder or thumb turn and  
single cylinder. Keyed alike, keyed to differ or  
master keyed. Odd sizes available in multiples  
of 5mm. Please ask for details.

**1977**  
House numerals and letters – 50mm (2")  
**1976**  
House numerals and letters – 45mm (1 3/4")  
**1979**  
House numerals and letters  
50mm (2"), 76mm (3") 101mm (4"), 152mm (6")

**1855**  
Old English style name plates. Gold on black.  
This is an approximate guide as capitals are larger than lower case letters and  
spaces must be allowed for between words. Our pattern shop will make your  
individual plate on the most appropriate size for the best results. For longer names  
it may be better to use two plates alongside each other or one above the other.  
**777**  
Also available in gold on black. Supplied with chain (not shown)  
368 x 73mm (14 1/2" x 2 7/8")



DOOR AND GATE FURNITURE  
DOOR ACCESSORIES



770  
AB P  
A



2156  
AB P  
A



769  
AB P  
A B



768  
AB P  
A



4146  
AB P  
A

**770**  
Door finger plate  
304 x 57mm (12" x 2 1/4")

**2156**  
Door finger plate  
339 x 73mm (13 3/8" x 2 7/8")

**769**  
Door finger plate  
304 x 63mm (12" x 2 1/2")

**768**  
Door finger plate  
222 x 73mm (8 3/4" x 2 7/8")

**4146**  
Door kicking plate  
Plain pattern manufactured  
from steel not iron  
Various sizes available



# GATE FITTINGS

## GATE STOPS, CATCHES, LOCKING BARS/ HASP AND STAPLES



**582**  
Automatic door catch  
76mm (3")

**2761**  
Gate catch  
317mm (12 1/2")

**4195**  
Hasp and staple  
152 x 127 x 57mm (6" x 5" x 2 1/4")  
Also available in a galvanised finish

**2758**  
Gate stop  
Length - 210mm (8 1/4")  
Height - 178mm (7")

**2760**  
Gate stop  
Length - 121mm (4 3/4")  
Width - 95mm (3 3/4")  
Height - 76mm (3")  
Opening - 64 x 50mm (2 1/2" x 2")

**4196**  
Hasp and staple  
127 x 83 x 29mm (5" x 3 1/4" x 1 1/8")  
Also available in a galvanised finish

**179/180**  
Gate stop with cement fixing (as shown - 179)  
Gate stop with floor plate fixing (180)  
Length - 330mm (13")  
Height - 254mm (10")

**1736**  
Stainless steel parliament hinge  
102 x 102mm (4" x 4")  
127 x 102mm (5" x 4")  
152 x 102mm (6" x 4")

**1127**  
101mm (4"), 127mm (5"), 152mm (6")

**3416**  
Safety hasp & staple  
Closed - 101 x 50mm (4 x 2")  
or 152 x 50mm (6 x 2")

**4290**  
152 x 38mm (6" x 1 1/2")  
203 x 38mm (8" x 1 1/2")  
254 x 41mm (10" x 1 5/8")  
305 x 44mm (12" x 1 3/4")  
356 x 48mm (14" x 1 7/8")  
406 x 51mm (16" x 2")  
457 x 60mm (18" x 2 3/8")  
508 x 60mm (20" x 2 3/8")

**1637**  
76mm (3"), 101mm (4"), 152mm (6"),  
203mm (8"), 254mm (10"), 305mm (12"),  
356mm (14"), 406mm (16"), 457mm (18")

**4509**  
Trap door hinge  
330 x 203mm (13" x 8") or  
381 x 203mm (15 3/4" x 8")

**3665**  
610 x 64mm (24" x 2 1/2")  
762 x 64mm (30" x 2 1/2")  
915 x 64mm (36" x 2 1/2")

**1011**  
76mm (3"), 101mm (4"), 152mm (6"),  
203mm (8"), 254mm (10"), 305mm (12"),  
356mm (14"), 406mm (16"), 457mm (18")

**3413**  
152 x 38mm (6" x 1 1/2")  
203 x 38mm (8" x 1 1/2")  
54 x 38mm (10" x 1 1/2")  
305 x 38mm (12" x 1 1/2")  
381 x 38mm (15" x 1 1/2")  
457 x 38mm (18" x 1 1/2")





Casement fastener 1185 and casement stay 1183 in Antique Black

## WINDOW FURNITURE CASEMENT FASTENERS



**1028**  
Hook & mortice – 95 x 67mm (3 3/4" x 2 3/4")

**1121**  
Hook & mortice. Reversible  
Matches 857 casement stay  
Backplate – 60 x 21mm (2 3/8" x 7/8")

**906**  
Hook & mortice. Reversible  
Backplate – 60 x 21mm (2 3/8" x 7/8")

**1027**  
Hook & mortice – 152 x 114mm (6" x 4")

**1121W**  
Wedge fastener  
Available as left or right handed  
Matches 857 casement stay  
57 x 17mm (2 1/4" x 5/8")

**838**  
Hook & mortice  
Available as left or right handed  
Backplate – 65 x 21mm (2 1/2" x 7/8")

**1182**  
Hook & mortice. Reversible  
Matches 1184 casement stay  
Backplate – 60 x 21mm (2 3/8" x 7/8")

**1166**  
Lockable  
Available as left or right handed  
Matches 857 casement stay  
57 x 17mm (2 1/4" x 5/8")

**1185**  
Hook & mortice. Reversible  
Matches 1078 casement stay  
Backplate – 65 x 21mm (2 1/2" x 7/8")

See glossary (p106) to understand the difference between hook and mortice plates



# WINDOW FURNITURE CASEMENT FASTENERS



**1177**  
AB P  
A



**1171**  
AB P  
A



**1193**  
AB P  
A



**1165**  
AB P  
A



**1167**  
AB P  
A



**1170**  
AB P  
A



**1181**  
AB P  
A B



**1601**  
AB P  
A



**1181NVL**  
AB P  
A

**1177**  
Hook & mortice. Reversible  
Backplate – 60 x 21mm (2 3/8" x 7/8")

**1165**  
Lockable. Left or right handed  
Matches 1180 casement stay  
57 x 18mm (2 1/4" x 3/4")

**1181**  
Hook & mortice. Reversible  
Matches 1180 casement stay  
Backplate – 60 x 21mm (2 3/8" x 7/8")

**1171**  
Lockable espagnolette fixing. Narrow  
backplate suitable for UPVC windows  
Matches 1180 casement stay  
Left or right handed  
Backplate – 15 x 68mm (5/8" x 2 5/8")

**1167**  
Three point lockable. Left or right handed  
Matches 1180 casement stay  
Backplate – 58 x 25mm (2 1/4" x 1")

**1601**  
Hook & mortice. Left or right handed  
Matches 1600 casement stay  
Backplate – 20 x 58mm (3/4" x 2 1/4")

**1193**  
Hook & mortice. Reversible  
Backplate – 60 x 21mm (2 3/8" x 7/8")

**1170**  
Lockable. Left or right handed  
Matches 1180 casement stay  
Backplate – 70 x 21mm (2 3/4" x 7/8")

**1181NVL**  
Lockable night vent fastener.  
Left or right handed  
Matches 1180 casement stay  
Backplate – 81 x 18mm (3 1/4" x 3/4")  
Non-locking version also available



Casement fastener 1181 and  
casement stay 1180 in Antique Black



# WINDOW FURNITURE CASEMENT FASTENERS



3365



2709



2723



140/141



144/145



146/147



1176

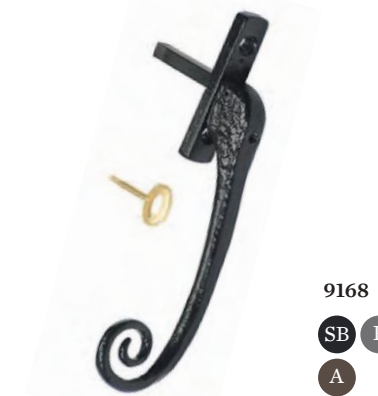

9168



1557



1460



1132



**3365**  
Hook & mortice. Reversible  
Backplate – 57 x 20mm (2 1/4" x 3/4")

**140/141**  
Hook (141) & mortice (140)  
Matches 171 casement stay  
Backplate – 85 x 25mm (3 3/8" x 1")

**1176**  
Raised tongue fastener suitable for fitting  
to windows with draught excluder  
Matches 1180 casement stay  
60 x 22mm (2 3/8" x 7/8")

**2709**  
Backplate – 55 x 15mm (2 1/8" x 5/8")

**144/145**  
Hook (145) & mortice (144)  
Matches 171 casement stay  
Backplate – 55 x 25mm (2 1/8" x 1")

**9168**  
Lockable espagnolette fixing. Narrow  
backplate suitable for UPVC windows  
Matches 1180 casement stay  
Left or right handed  
Backplate – 70 x 15mm (2 3/4" x 5/8")  
Handle – 130mm (5")

**2723**  
Locking catch  
Backplate – 55 x 28mm (2 1/8" x 1 1/8")  
Locking snib plate – 55 x 20mm (2 1/8" x 3/4")

**146/147**  
Hook (147) & mortice (146). Lockable  
Left or right handed available  
Matches 171 casement stay  
Backplate – 68 x 19mm (2 5/8" x 3/4")

**1460** Sash window fastener  
Plate – 70 x 20mm (2 3/4" x 7/8")  
Catchplate – 68 x 15mm (2 3/4" x 5/8")

**1557** Window fastener  
73 x 26mm (2 7/8" x 1")

**1132** Window fastener  
60 x 15mm (2 3/8" x 5/8")





# WINDOW FURNITURE CASEMENT STAYS



1183

AB P  
A

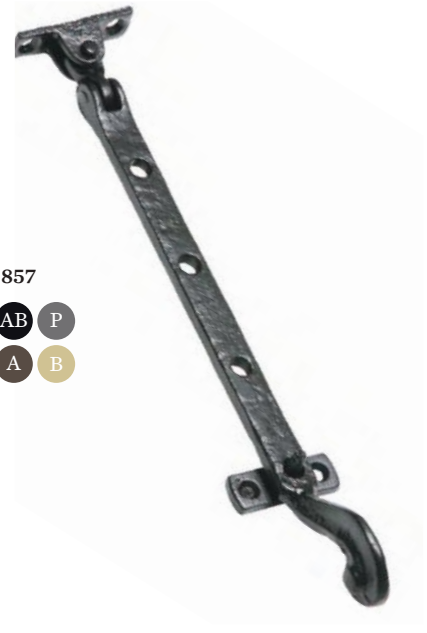

857

AB P  
A B

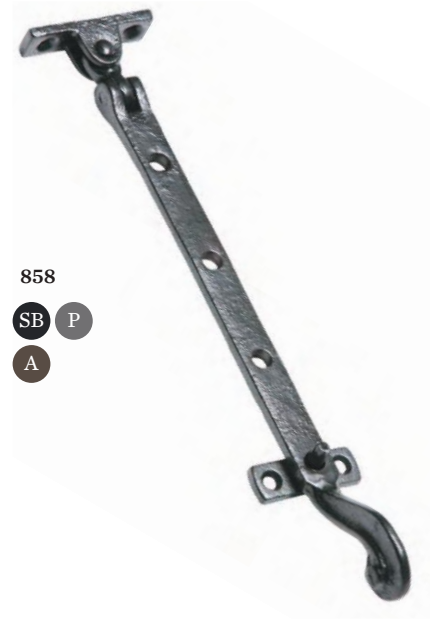

858

SB P  
A



905

AB P  
A



1180

AB P  
A B



171

SB P  
A B

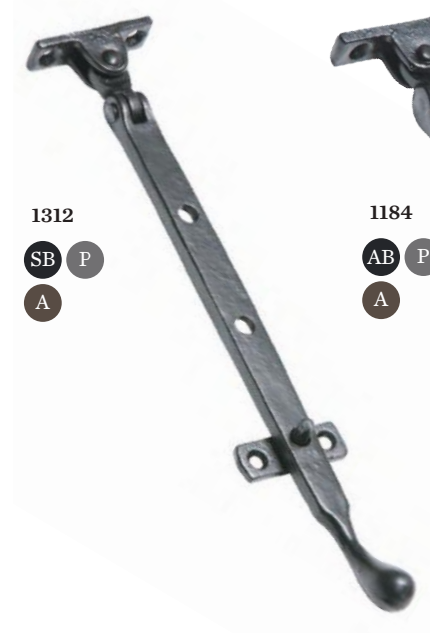

1312

SB P  
A



1184

AB P  
A



504

SB P  
A



1600

SB P  
A



Casement stay 1180 in Brass

**1183**  
203mm (8"), 254mm (10"), 304mm (12")

**905**  
254mm (10") or 304mm (12")

**857**  
Matches 1121 fastener  
191mm (7"), 228mm (9"),  
279mm (11"), 330mm (13")

**1180**  
Matches 1181 fastener  
203mm (8"), 254mm (10"), 304mm (12")

**858**  
279mm (11") or 330mm (13")

**171**  
152mm (6"), 203mm (8"),  
254mm (10"), 305mm (12")

**1312**  
203mm (8"), 254mm (10"),  
305mm (12")

**1184**  
Matches 1182 fastener  
203mm (8"), 254mm (10"),  
304mm (12")

**504**  
254mm (10")

**1600**  
Matches 1601 fastener  
304mm (12")



# WINDOW FURNITURE CASEMENT STAYS

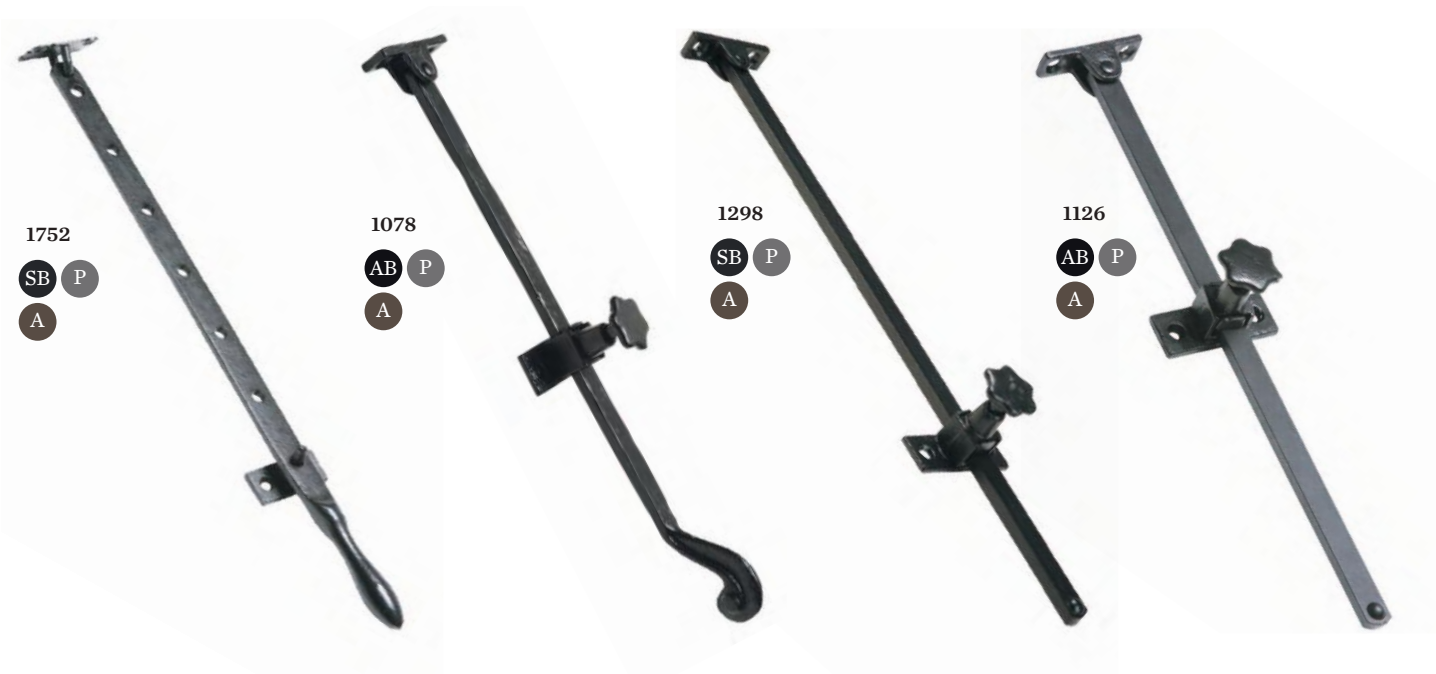

1752  
SB P  
A

1078  
AB P  
A

1298  
SB P  
A

1126  
AB P  
A



4120  
SB P  
A

883  
SB P  
A

3900  
SB P  
A

**1752**  
Skylight stay  
254mm (10"), 305mm (12")  
381mm (15"), 457mm (18")  
533mm (21"), 610mm (24")  
686mm (27"), 762mm (30")  
915mm (36"), 1066mm (42")  
1220mm (48")

**1078**  
279mm (11") or 330mm (13")  
**883**  
Shutter flap. Reversible  
Spike - 178mm (7")

**1298**  
152mm (6"), 203mm (8"),  
254mm (10"), 305mm (12")  
381mm (15")  
**3900**  
178mm (7") or 216mm (8")

**1126**  
Screw down  
254mm (10"), 304mm (12"),  
381mm (15")



3754  
SB P  
A B

672  
AB P  
A

3475  
SB P  
A



3998  
SB P  
A

116  
SB P  
A B

117  
SB P  
A



607/607A  
SB P  
A

5182

5146  
AB P

**3754**  
Fanlight catch. Flush or recessed  
127mm (5") or 178mm (7")

**672**  
Shutter fastener - 133 x 50mm (5 1/4" x 2")  
Spike - 108mm (4 1/4")

**3475**  
Shutter flap - 152 x 50mm (6" x 2")  
Spike - 108mm (4 1/4")

**3998**  
Rule jointed stay  
Open - 254mm (10") or 305mm (12")

**116**  
Locking pivot

**117**  
Side fixing pivot

**607/607A**  
Spring fanlight catch with  
gun metal shoots  
32 x 44mm (1 1/4" x 1 3/4")

**5182**  
Window restrictor  
White (5182)  
Dark brown (5180)  
Light brown (5181)

**5145**  
Rack bolt key  
**5146**  
Window rack bolt



# CABINET AND DRAWER FURNITURE HANDLES



997  
AB P  
A



1528  
AB P  
A



1217  
AB P  
A



1013  
AB P  
A



1192  
AB P  
A



985  
AB P  
A



1137  
AB P  
A



1543  
AB P  
A



834  
AB P  
A



932  
AB P  
A

**997**  
Drawer handle  
55 x 45mm (2 1/5" x 1 4/5")

**1013**  
Drawer handle  
Diameter - 35mm (1 2/5")

**1137**  
Turn button - 62mm (2 1/2")

**1543**  
Drawer handle  
Diameter - 42mm (1 5/8")

**1528**  
Drawer handle  
80 x 35mm (3 1/7" x 1 2/5")

**1192**  
Drawer handle  
40 x 40mm (1 4/7" x 1 4/7")

**834**  
Drawer pull  
Plate - 171 x 70mm (6 3/4" x 2 3/4")  
Handle - 127mm (5")

**1217**  
Drawer handle  
Diameter - 35mm (1 2/5")

**985**  
Drawer handle  
80 x 35mm (3 1/7" x 1 2/5")

**932**  
Hasp and staple  
148 x 77mm (5 7/8" x 3")

Handle 834 and hasp & staple 932  
in Antique Black





## CABINET AND DRAWER FURNITURE KNOBS AND PULLS



1195

AB P  
A



1949

SB P  
A



1119

SB P  
A



1135

AB P  
A



2587

AB P  
A



2586

AB P  
A

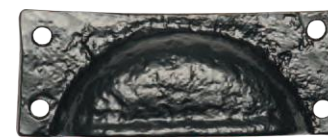

1549

AB P  
A



1194

AB P  
A



3960

AB P  
A

**1195**  
Cupboard knob  
Bolt or screw - 35mm (1 3/8")  
Rose - 38mm (1 1/2")

**1135**  
Cupboard knob  
Screw - 25mm (1")

**1549**  
Drawer pull - 89mm (3 1/2")

**1949**  
Cupboard knob  
Diameter - 25mm (1")

**2587**  
Sash pull - 63mm (2 1/2")

**1194**  
Drawer pull  
Knob - 114 x 50mm (4 1/2" x 2")

**1119**  
Turn button - 62mm (2 1/2")

**2586**  
Sash pull  
79 x 31mm (3 1/8" x 1 1/4")  
Projection - 31mm (1 1/4")

**3960**  
Drawer pull - 108mm (4 1/4")



HOME ACCESSORIES  
HOOKS AND BRACKETS



734  
AB P  
A



837  
AB P  
A



4269  
SB P  
A



1129  
AB P  
A B



4463  
AB P  
A



212  
SB P  
A



1130  
AB P  
A B

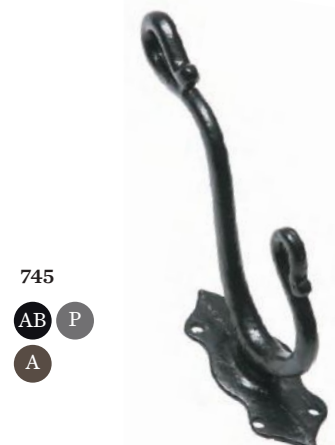

745  
AB P  
A



720  
AB P  
A

**734**  
Hat and coat hook  
101mm (4")

**1129**  
Coat hook  
Backplate - 40 x 40mm (1 1/2" x 1 1/2")  
Projection - 65mm (2 1/2")

**1130**  
Hat and coat hook  
152mm (6")

**837**  
Hat and coat hook  
127mm (5")

**4463**  
Fleur-de-lys hook  
Backplate - 54 x 54mm (2" x 2")  
Projection - 70mm (2 3/4")

**745**  
Hat and coat hook  
152mm (5 1/4")

**4269**  
Hat and coat hook  
140 x 76mm (5 1/2 x 3")

**212**  
Hat and coat hook  
152mm (6")

**720**  
Hat and coat hook  
152mm (6")



Hat and coat hook 1130 in Antique Black



HOME ACCESSORIES  
HOOKS AND BRACKETS



2378  
SB P  
A



357  
SB P  
A



1173  
AB P  
A B



836  
AB P  
A



1174  
AB P  
A B



1238  
AB P  
A



3491  
SB P  
A



3498  
SB P  
A



3499  
SB P  
A



3497  
AB P  
A



5130  
AB P  
A



5131  
AB P  
A



Hat and coat hook 1130 & cupboard knob 1195 both in Antique Black

**2378**  
Hat and coat hook  
146 x 76mm (5 3/4" x 3")

**836**  
Coat hook  
Backplate - 50 x 50mm (2" x 2")  
Projection - 70mm (2 3/4")

**3491**  
Handrail bracket  
50mm (2"), 64mm (2 1/2"), 76mm (3")

**357**  
Coat hook - 50 x 24mm (2" x 1")  
Projection - 50mm (2")

**1174**  
Coat hook - 80 x 50mm (3 1/8" x 2")  
Projection - 35mm (1 3/8")

**3498**  
Handrail bracket  
50mm (2"), 64mm (2 1/2"), 76mm (3")

**1173**  
Coat hook - 50 x 24mm (2" x 1")  
Projection - 50mm (2")

**1238**  
Picture hook - 45mm (1 3/4")  
Projection - 20mm (3/4")

**3499**  
Extra strong handrail bracket  
64mm (2 1/2") or 83mm (3 1/4")

**3497**  
Handrail bracket  
Projection - 50mm (2")

**5130**  
Clothes rack/airer  
Length - 1,524 mm (60")  
Brackets - 349mm (13 3/4")

**5131**  
Shelf unit  
609mm (24"), 914mm (36"),  
1219mm (48"), 1524mm (60")



HOME ACCESSORIES  
LIGHTING



401/400

SB P  
A



406

SB P  
A



403

SB P  
A



407

SB P  
A



405

SB P  
A



**401**  
Hanging wall lantern with hexagonal cage  
552 x 15mm (21 3/4" x 5/8")  
Plate - 254 x 50mm (10" x 2")  
Canopy - 190mm (7 1/2")

**403**  
Hanging wall lantern  
Supplied with wall bracket and ceiling rose or corner bracket  
Plate - 260 x 44mm (10 1/4" x 1 3/4")  
Frame - 203 x 114mm (8" x 4 1/2")

**400**  
Hanging wall lantern with square cage  
177 x 177mm (7" x 7"),  
Plate - 254 x 50mm (10" x 2")  
Canopy - 228 x 228mm (9" x 9")

**407**  
Hanging wall lantern with hexagonal cage  
Plate - 339 x 73mm (13" x 2 7/8")  
Projection - 200mm (8")  
Cage - 175 x 150mm (7" x 6")

**406**  
Wall light  
Bracket only supplied, not wired  
Candle drips, bulbs or shades not included  
Twin - 263 x 276mm (10 3/8" x 10 7/8")  
Single - 263 x 148mm (10 7/8" x 5 3/4")

**405**  
Hanging wall lantern  
Supplied with wall bracket & ceiling rose or corner bracket  
Frame - 203 x 114mm (8" x 4 1/2")  
Height - 304mm (12")

HOME ACCESSORIES  
PATIO AND FIRESIDE



813

AB P  
A



3612

AB P  
A



3600

SB P  
A



4601

AB P  
A



4342

SB P  
A



4539

SB P  
A



2842

SB P  
A



3023

AB P  
A



4185

AB P  
A

**813**  
Wall bracket  
101 x 76mm (4" x 3")  
152 x 127mm (6" x 5")  
222 x 173mm (9" x 7")

**4601**  
Basket hook  
Projection - 228mm (9"),  
304mm (12"), 381mm (15")

**2842**  
Fork, broom & shovel holder  
Projection - 76mm (3")  
Plate - 114 x 51mm (4 1/2" x 2")

**3612**  
Flower pot holder  
260 x 190mm (10 1/4" x 7 1/2")

**4342**  
Boot scraper  
Height - 356mm (14")  
Width - 196mm (7 3/4")

**3023**  
Coal tongs  
277mm (11 1/2")

**3600**  
Basket hook  
152mm (6"), 203mm (8"),  
254mm (10"), 305mm (12")

**4539**  
Boot scraper  
Width - 356mm (14")  
Depth - 330mm (13")

**4185**  
Fire poker  
457mm (18")





## BLACKSMITH FORGE RANGE

- 84 Door furniture
- 88 Window furniture
- 90 Hooks and handles

*The traditional handcrafted nature of our production process means that all listed sizes are approximate.*



# BLACKSMITH FORGE RANGE DOOR FURNITURE



6058

SB A



6080

SB A



6050/6051

SB A



6052/6053

SB A



**6058**

Ring knocker

Backplate – 115mm (4 1/2")

Ring – 110mm (4 3/8")

**6050/6051**

Lever handle

Sprung (6050) – lock, latch or bathroom

Unsprung (6051) – lock, latch or Euro

270 x 38mm (10 3/4" x 1 1/2")

**6080**

Letter plate

Outside – 267 x 114mm (10 1/2" x 4 1/2")

Opening – 203 x 41mm (8" x 1 5/8")

Fixing bolt centres – 235mm (9 1/4")

**6052/6053**

Lever handle – sprung

Lock, latch or bathroom

240 x 40mm (9 3/8" x 1 5/8")



# BLACKSMITH FORGE RANGE DOOR FURNITURE



6059  
SB A



6068  
SB A



6082  
SB A



6057  
SB A



6056  
SB A



6081  
SB A

**6059**  
Bolt - straight or cranked  
102mm (4"), 152mm (6")

**6057**  
Door hinge  
152mm (6"), 229mm (9")  
305mm (12"), 381mm (15")  
457mm (18"), 559mm (22")

**6068**  
Bolt - straight or cranked  
102mm (4"), 152mm (6")

**6056**  
Thumb latch  
Handle - 126 x 47mm (5" x 1 7/8")  
Latch bar - 84mm (3 1/4")

**6082**  
Door hinge  
152mm (6"), 229mm (9")  
305mm (12"), 381mm (15")  
457mm (18"), 559mm (22")

**6081**  
Cylinder pull  
Backplate - 85 x 50mm (3 3/8" x 2")  
Projection - 20mm (3/4")

See glossary (p106) to understand the difference between straight and cranked



BLACKSMITH FORGE RANGE  
WINDOW FURNITURE



6069

SB A



6070

SB A



6062

SB A



6063

SB A

**6069**  
Casement stay  
203mm (8"), 254mm (10"), 305mm (12")

**6070**  
Casement stay  
203mm (8"), 254mm (10"), 305mm (12")

**6062**  
Lockable casement fastener  
Hook or mortice. Left or right handed  
Fixing plate - 56 x 15mm (2 1/4" x 5/8")  
Handle length - 100mm (4")

**6063**  
Lockable casement fastener  
Hook or mortice. Left or right handed  
Fixing plate - 56 x 15mm (2 1/4" x 5/8")  
Handle length - 100mm (4")



Casement fastener 6063, casement stay 6070  
and casement stay 6069 all in Smooth Black



BLACKSMITH FORGE RANGE  
HOOKS AND HANDLES



6064  
SB A



6065  
SB A



6060  
SB A



6061  
SB A



6067  
SB A



6066  
SB A

**6064**  
Coat hook  
Plate – 50 x 38mm  
(2" x 1 1/2")  
Projection – 54mm (2 1/8")

**6067**  
Hat and coat hook  
Plate – 80mm x 20mm  
(3 1/8" x 3/4")  
Projection – 60mm (2 3/8")

**6065**  
Coat hook  
Plate – 72 x 54mm  
(2 3/4" x 2 1/8")  
Projection – 58mm (2 1/4")

**6066**  
Coat hook  
Plate – 80 x 20mm  
(3 1/8" x 3/4")  
Projection – 45mm (1 3/4")

**6060**  
Pull handle  
102mm (4"), 152mm (6"),  
203mm (8")

**6061**  
Pull handle  
102mm (4"), 152mm (6"),  
203mm (8")



Hooks 6065 in Smooth Black  
and handles 6061 in Argent



# CAST BRASS RANGE

- 93 Door furniture
- 99 Window furniture
- 100 Hooks, handles and locks

*The traditional handcrafted nature of our production process means that all listed sizes are approximate.*



## CAST BRASS RANGE DOOR FURNITURE



**B4896**



**B2621**



**B1073**



**B1083**



**B1102**

**B4896**  
Lions head door knocker  
114 x 95mm (4 1/2" x 3 3/4")  
Ring - 101mm (4")

**B1073**  
Letter plate  
Outside - 362 x 88mm (14 1/4" x 3 1/2")  
Opening - 203 x 44mm (8" x 1 3/4")  
Fixing bolt centres - 277mm (10 3/4")

**B1102**  
Letter plate  
Internal flap - 292 x 76mm (11 1/2" x 3")

**B2621**  
Bat bedroom door knocker  
76 x 89mm (3" x 3 1/2")

**B1083**  
Letter plate  
Outside - 266 x 108mm (10 1/2" x 4 1/2")  
Opening - 203 x 44mm (8" x 1 3/4")  
Fixing bolt centres - 241mm (9 1/4")



CAST BRASS RANGE  
DOOR FURNITURE



B2439



B2439SP



B2450



B2454



B2451



B2561

**B2439**  
Lever handle  
Lock, latch or bathroom  
152 x 38mm (6" x 1 1/2")  
Short latch only - 101 x 38mm (4" x 1 1/2")

**B2454**  
Lever handle  
Lock, latch or bathroom  
Plate - 164 x 47mm (6 1/2" x 1 7/8")

**B2439SP**  
Lever handle  
Short plate, latch only  
Plate 101 x 38mm (4" x 1 1/2")

**B2451**  
Lever handle  
Lock, latch or bathroom  
164 x 47mm (6 1/2" x 1 7/8")

**B2450**  
Lever handle  
Lock, latch or bathroom  
Plate - 190 x 55mm (7 1/2" x 2 1/4")

**B2561**  
Lever handle  
Lock - 140 x 38mm (5 1/2" x 1 1/2")  
Latch - 114 x 38mm (4 1/2" x 1 1/2")



Casement stay B1180 in Cast Brass



B3603



B564



B769



B2156

**B3603**  
Pull handle  
191 x 64mm (7 1/2" x 2 1/2")

**B564**  
Pull handle  
101mm (4"), 127mm (5"),  
152mm (6"), 177mm (7"),  
228mm (9")

**B769**  
Door finger plate  
304 x 63mm (12" x 2 1/2")

**B2156**  
Door finger plate  
339 x 73mm (13 3/8" x 2 7/8")



# CAST BRASS RANGE DOOR FURNITURE



**B926**

**B3619**

**B3613**



**B814**

**B3679**

**B798**



**B1155**

**B1131**

**B1157**

**B926**  
Hinge – suitable for cabinet doors  
83 x 45mm (3 1/4" x 1 3/4")

**B814**  
Hinge  
152 x 63mm (6" x 2 1/2")  
263 x 101mm (10 1/2" x 4")  
313 x 101mm (12" x 4")  
388 x 101mm (15" x 4")  
456 x 101mm (18" x 4")

**B1155**  
Straight or cranked  
Plate – 152 x 45mm (6" x 1 3/4")  
or 203 x 54mm (8" x 2 1/8")  
Straight only  
Plate – 254 x 54mm (10" x 2 1/8")  
or 304 x 54mm (12" x 2 1/8")

**B3619**  
Thumb latch  
Handle – 203 x 63mm (8" x 2 1/2")  
Latch – 127mm (5")

**B3679**  
Hinge – 304 x 108mm (12" x 4.25")  
or 381 x 108mm (15" x 4.25")

**B1131**  
Straight or cranked  
Plate – 101 x 25mm (4" x 1")

**B3613**  
Thumb latch handle  
228 x 63mm (7 3/4" x 2 1/2")  
Latch – 197mm (7 3/4")

**B798**  
Hinge – 304 x 139mm (12" x 5 1/2")

**B1157**  
Straight or cranked  
Plate – 114 x 38mm (4 1/2" x 1 1/2")  
Bolt – 127mm (5")  
Plate – 190 x 57mm (7 1/2" x 2 1/4")  
Bolt – 203mm (8")

Straight only  
Plate – 241 x 57mm (9 1/2" x 2 1/4")  
Bolt – 254mm (10")  
Plate – 292 x 57mm (11 1/2" x 2 1/4")  
Bolt – 304mm (12")

*See glossary (p106) to understand the difference between straight and cranked*



**B1205**

**B1550**

**B1551**

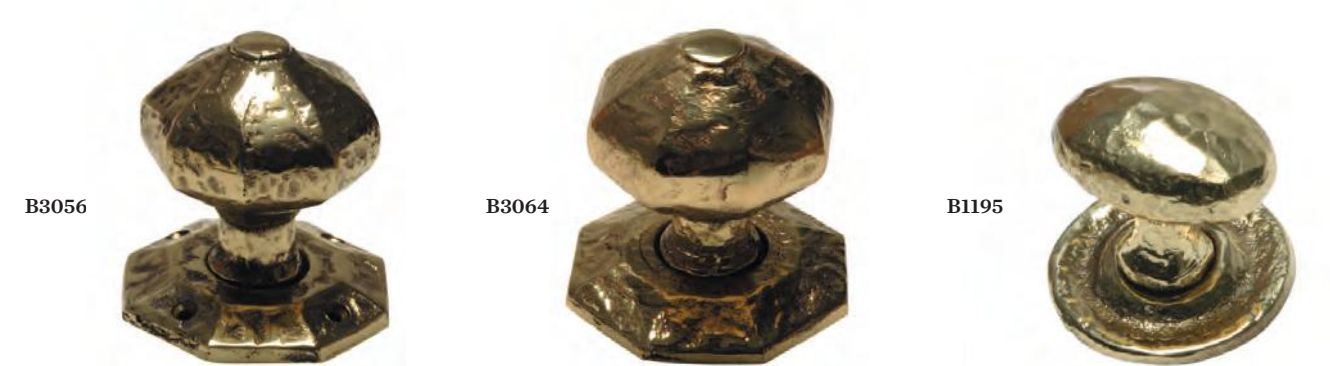

**B3056**

**B3064**

**B1195**



**B1081**

**B153**

**B1979**

**B1205**  
Door knob  
Mortice or rim  
Knob – 50mm (2")  
Plate – 85mm (3 3/8")

**B3056**  
Door knob  
Mortice or rim  
Knob – 57mm (2 1/4")  
Plate – 63mm (2 1/2")

**B1081**  
Door stud.  
Drive or screw  
Head – 19mm (3/4")

**B1550**  
Door knob  
Mortice or rim  
Knob – 63 x 39mm (2 1/2" x 1 1/2")  
Plate – 57mm (2 1/4")

**B3064**  
Centre door knob  
Knob – 70mm (2 3/4")  
Plate – 76mm (3")

**B153**  
Door stud. Screw  
Head – 22mm (7/8")

**B1551**  
Door knob  
Mortice or rim  
Knob – 63 x 38mm (2 1/2" x 1 1/2")  
Plate – 67 x 50mm (2 5/8" x 2")

**B1195**  
Cupboard knob  
35mm (1 3/8")  
Rose – 38mm (1 1/2")

**B1979**  
Letters and numerals  
76mm (3")

*See glossary (p106) to understand the difference between mortice and rim*



CAST BRASS RANGE  
DOOR FURNITURE

B1402



B1401



B1065



B1485



B1486



B1150



B1761



B1493



B1502



**B1402**  
Escutcheon  
51 x 51mm (2" x 2")

**B1485**  
Cylinder latch pull  
85 x 50mm (3 1/2" x 2")

**B1761**  
Bell push  
121 x 32mm (4 3/4" x 1 1/4")

**B1401**  
Escutcheon  
51 x 51mm (2" x 2")

**B1486**  
Cylinder latch cover/pull  
127 x 58mm (5" x 2 1/2")

**B1493**  
Escutcheon  
73 x 25mm (2 7/8" x 1")

**B1065**  
Escutcheon  
54 x 25mm (2 1/8" x 1")

**B1150**  
Privacy bolt with vacant/engaged sign  
Latch - 64 x 25mm (2 1/2" x 1")  
Catch - 64 x 20mm (2 1/2" x 3/4")  
Disc - 70 x 70mm (2 3/4" x 2 3/4")

**B1502**  
Escutcheon  
45 x 30mm (1 3/4" x 1 1/8")

CAST BRASS RANGE  
WINDOW FURNITURE

B140/  
B141



B144/  
B145



B1165



B1181



B1166



B1121



B1180



B171



B857



**B140/B141**  
Casement fastener  
Hook (141) & mortice (140). Smooth finish  
Matches 171 casement stay  
Backplate - 85 x 25mm (3 3/8" x 1")

**B1181**  
Casement fastener  
Hook & mortice. Reversible  
Matches 1180 casement stay  
Backplate - 60 x 21mm (2 3/8" x 7/8")

**B1180**  
Casement stay  
203mm (8"), 254mm (10"), 304mm (12")

*See glossary (p106) to understand the difference between hook and mortice plates*

**B144/B145**  
Casement fastener  
Hook (145) & mortice (144). Smooth finish  
Matches 171 casement stay  
Backplate - 55 x 25mm (2 1/8" x 1")

**B1166**  
Casement fastener. Lockable.  
Available as left or right handed.  
Matches 857 casement stay  
57 x 18mm (2 1/4" x 3/4")

**B171**  
Casement stay. Smooth finish  
152mm (6"), 203mm (8"),  
254mm (10"), 305mm (12")

**B1165**  
Casement fastener. Lockable.  
Available as left or right handed.  
Matches 1180 casement stay  
57 x 18mm (2 1/4" x 3/4")

**B1121**  
Casement fastener  
Hook & mortice. Reversible  
Matches 857 casement stay  
Backplate - 60 x 21mm (2 3/8" x 7/8")

**B857**  
Casement stay. Matches 1121 fastener  
191mm (7"), 228mm (9"),  
279mm (11"), 330mm (13")



# CAST BRASS RANGE

## HOOKS, HANDLES AND LOCKS

B1174



B1173



B1129



B406



B1204



B116



B1130



B4463



B632



B3754



B679



B916



B910



**B1174**  
Coat hook - 80 x 50mm (3 1/8" x 2")  
Projection - 35mm (1 3/8")

**B1130**  
Hat and coat hook  
152mm (6")

**B679**  
Ring handle  
Rose - 63mm (2 1/2")  
Handle - 76mm (3")

**B1173**  
Coat hook - 50 x 24mm (2" x 1")  
Projection - 50mm (2")

**B4463**  
Fleur-de-lys hook  
Backplate - 54 x 54mm (2" x 2")  
Projection - 70mm (2 3/4")

**B916**  
Drawer handle  
67 x 36mm (2 3/5" x 1 7/16")

**B1129**  
Coat hook  
Backplate - 40 x 40mm (1 1/2" x 1 1/2")  
Projection - 65mm (2 1/2")

**B632**  
Ring handle  
Rose - 101mm (4")  
Handle - 101mm (4")

**B910**  
Drawer handle  
50 x 25mm (2" x 1")

**B406**  
Interior wall lamp  
Double - 263 x 276mm (10 3/8" x 10 7/8")  
Single - 263 x 148mm (10 7/8" x 5 3/4")

**B3754**  
Fanlight catch  
Smooth finish. Also in flush fitting.  
127mm (5") or 178mm (7")

**B1204**  
Rim lock set  
Lock or latch. Supplied with 1550 knob,  
oval escutcheon and Wilkes spindle.  
Lock body - 125 x 103 x 19mm  
(4 3/4" x 4" x 3/4")

**B116**  
Locking pivot  
For use with casement stay  
Smooth finish



# RAWNSLEY RANGE

The traditional handcrafted nature of our production process means that all listed sizes are approximate.

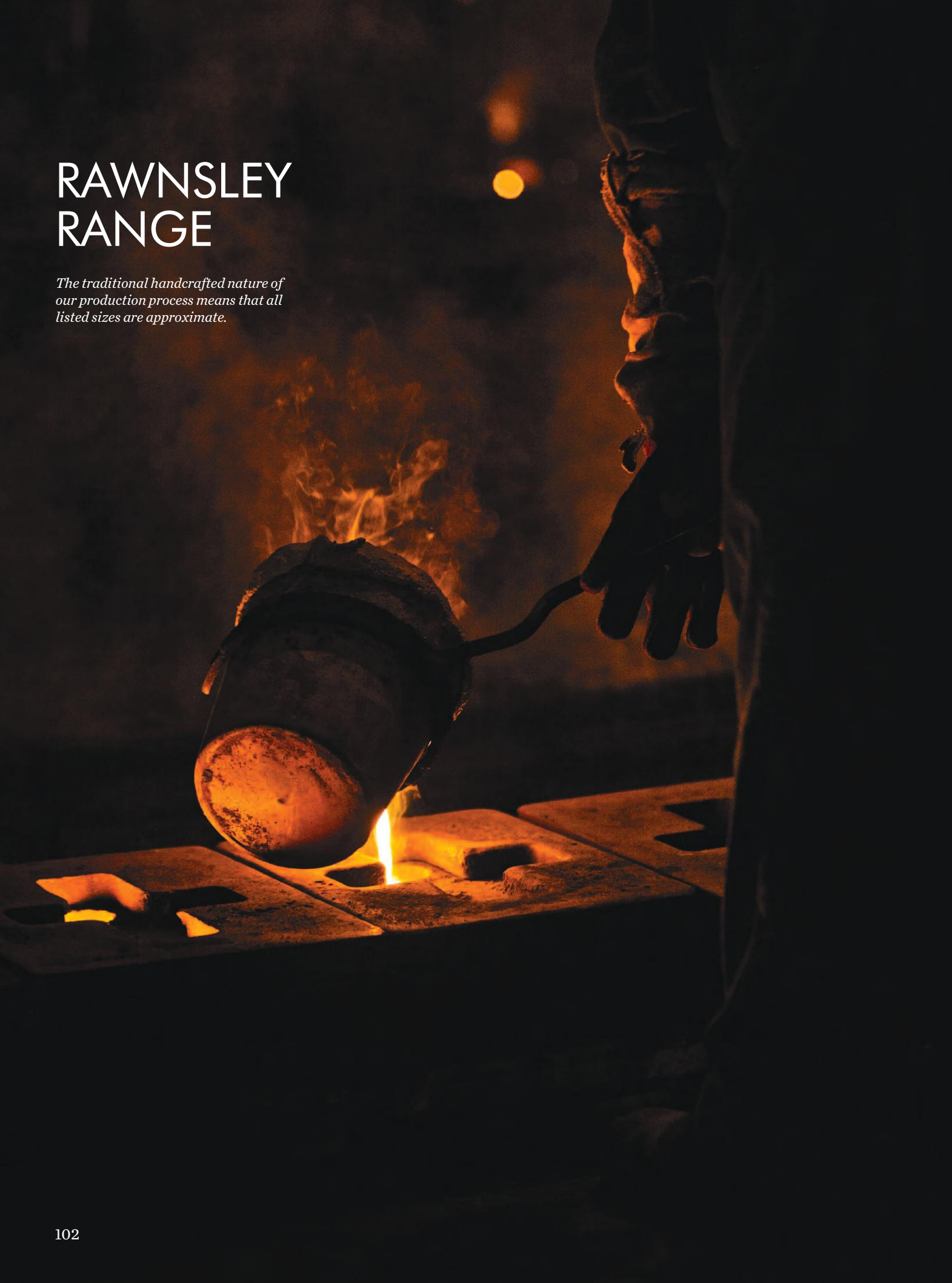

## RAWNSLEY RANGE



**T540**



**T541**



**WPE906**



**WPE911**



**T710**



**T940**



**T1102**



**RLC451C**



**T540**

Letter plate  
Width - 250mm (10")  
Aperture - 183 x 25mm (7 1/4" x 1")

**WPE906**

Door knocker  
Length - 228mm (9 1/2")

**T940**

Door knob  
Mortice or rim  
Knob - 63mm (2 1/2")

**T541**

Letter plate  
Width - 205mm (8")  
Aperture - 121 x 25mm (4 3/4" x 1")

**WPE911**

Door knocker  
Length - 190mm (7 1/2")

**T1102**

Drawer pull  
Width - 115mm (4 1/2")

**T710**

Door knocker  
Length - 223mm (8")

**RLC451C**

Rimlock  
With or without rimlock  
Supplied with T940 knob and escutcheon  
Lock body - 158 x 115mm (6 1/4" x 4 1/2")





### NEED INSPIRATION?

Have a peek at the inspiration page on our website for more ideas...

## GET YOUR HANDS ON OUR PRODUCTS

For a full up-to-date list of local, UK and international stockists please visit our website.

[KIRKPATRICK.CO.UK](http://KIRKPATRICK.CO.UK)

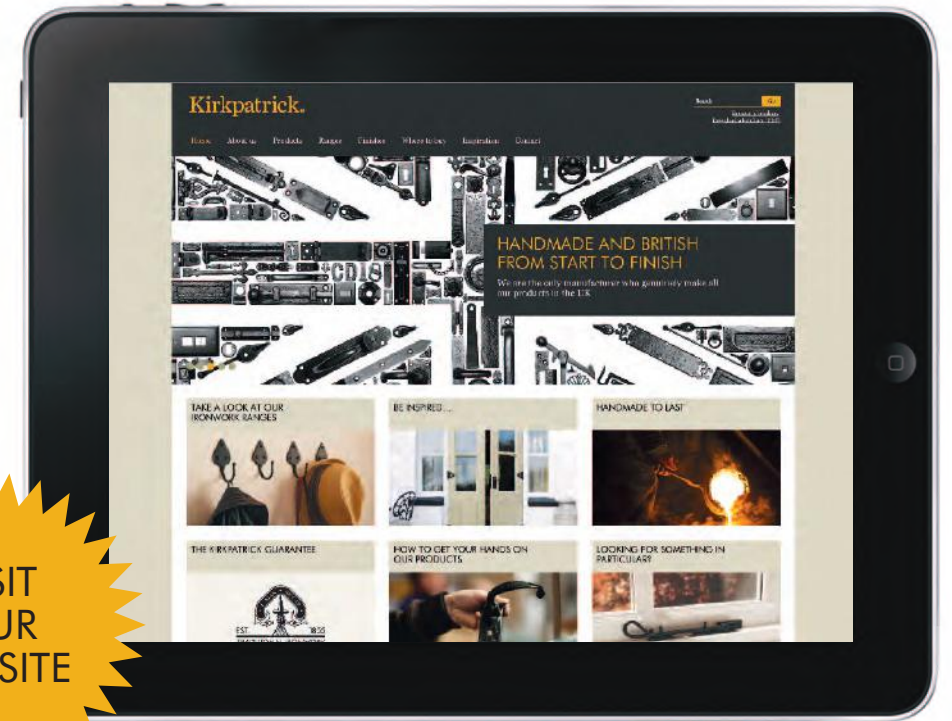

VISIT OUR WEBSITE

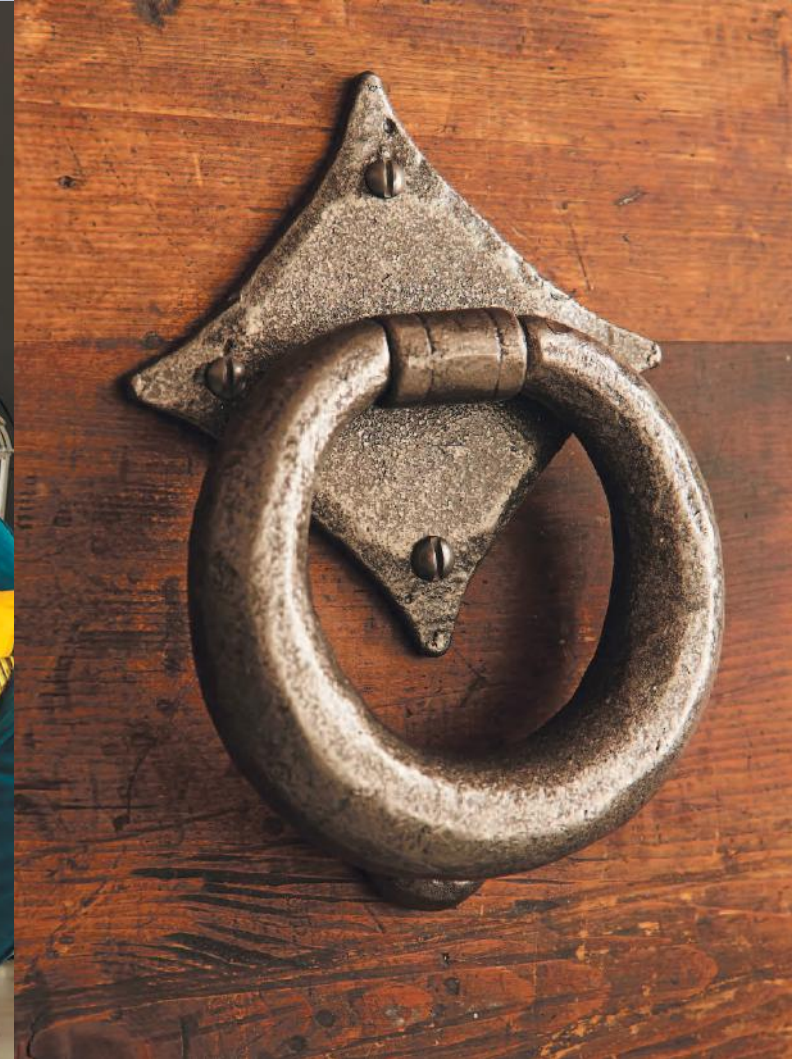



## LEVER HANDLE LOCK TYPES

### Lock

A traditional key operated locking system.

### Latch

A handle operated, spring loaded tongue which 'clicks' shut, holding the door closed but not locking it.

### Bathroom

A turn and release locking system which allows the door to be locked and unlocked from one side only for privacy without the use of a key.

### Euro cylinder

A keyhole shaped lock barrel which fits into an appropriately shaped hole within the door and its handle.

### Oval lock

Very similar to a euro cylinder but with an oval rather than keyhole shaped barrel.



Lock

Latch



Euro cylinder

## THUMB LATCH TYPES CRANKED OR STRAIGHT?

### Cranked

The handle is offset to one side slightly to accommodate for a left hand or right handed door. Sometimes the actual thumb lever can be off-set also.



Straight

Cranked

## BOLT TYPES CRANKED OR STRAIGHT?

### Straight

The bolt sits on the same plane as the bolt fixing.

### Cranked

A cranked bolt is angled out like a step to allow it to fix in position at a 90 degree angle to the actual bolt.



Straight



Cranked

## DOOR KNOBS/LOCKS MORTICE OR RIM?

### Mortice

A mortice knob can be turned to operate a tongue latch within the door that slots into a mortice (hole) in the door frame, holding the door closed or releasing it.

### Rim

A rim knob sits on top of a rim latch or rim lock box, which is mounted onto the face of the door. Turning the knob operates a tongue latch inside the box which slots into a keeper on the door frame, securing or releasing the door.



Mortice

Rim

## WINDOW FASTENINGS HOOK OR MORTICE?

### Hook

A hook fastening slots into a protruding hook attached to the window frame.

### Mortice

A mortice fastening fits into a recess in the window frame.



Hook

Mortice

# AND FINALLY...



## BESPOKE ITEMS

With our many years' experience of casting malleable iron we have the capability to make bespoke items to replace unique items which are no longer available.

This service is typically used when renovating listed buildings. To do this we would normally require a sample of the existing product so that we can produce a new pattern from which to make a casting.

## REFURBISHING

Iron products are very durable and can last for many years. If a listed building is being renovated there is very often the option to re-use the original ironmongery.

However, although the actual product is still functional and strong it is often the case that it has been painted over several times and its original beauty has been lost.

We have the capability to restore such products to their original glory by using the skills and techniques built up over 160 years.

## TAKING CARE

Metal in most forms is susceptible to corrosion. Depending upon their function our malleable iron products are subjected to either a one or two stage coating process followed by stove drying to form our durable and hard wearing traditional finish.

Over time the finish can be affected particularly where moving parts rub together. To protect your ironwork we recommend that any moving parts are lightly oiled prior to fitting. We also recommend wiping the products with a lightly oiled cloth from time to time to remove any harmful deposits and reapplying a small amount of oil to moving parts. This is particularly advisable if located near the coastline. We would recommend a three-in-one or WD-40 type lubricant.

If the protective coating is damaged or chipped in any way, a Hammerite type paint should be applied to maintain protection against corrosion.

By adopting this simple advice you can help ensure that your Kirkpatrick products will remain both functional and decorative and will last a lifetime.





# PRODUCT INDEX

Product Code	Pg	Product Code	Pg	Product Code	Pg	Product Code	Pg	Product Code	Pg	Product Code	Pg	Product Code	Pg	Product Code	Pg
116	71	814F	22	1117	48	1239	48	1814	19	2758	60	4120	70	B116	100
117	71	816	20	1119	75	1246	29	1820	19	2760	60	4146	59	B140 / B141	99
140 / 141	66	817	23	1120	21	1248	28	1855	57	2761	60	4185	81	B144 / B145	99
144	66	819	22	1121	63	1249	29	1883	43	2788	42	4195	60	B153	97
145	66	820	22	1121W	63	1251	28	1911	31	2842	81	4196	60	B171	99
146 / 147	66	821	23	1124	25	1253	53	1949	75	2967	37	4269	76	B406	100
153	55	828	53	1125	42	1257	34	1963	32	2968	37	4290	61	B564	95
171	68	829	21	1126	70	1298	70	1976	57	3011	56	4305	27	B632	100
179	60	830	33	1127	61	1312	69	1977	57	3012	56	4320	26	B679	100
180	60	832	50	1129	76	1324	31	1979	57	3023	81	4321	34	B769	95
212	76	834	73	1130	76	1400	56	2105	43	3045	56	4342	81	B798	96
357	78	836	78	1131	33	1401	56	2155	41	3056	46	4438	29	B814	96
400 / 401	80	837	76	1132	66	1460	66	2156	59	3064	46	4463	76	B857	99
403	80	838	63	1135	75	1484	53	2157	41	3066	46	4509	61	B910	100
405	80	846	48	1137	73	1485	53	2164	41	3067	45	4539	81	B916	100
406	80	853	54	1145	25	1486	53	2167	41	3072	46	4601	81	B926	96
407	80	857	68	1146	29	1487	53	2172	41	3075	47	4748	54	B1065	98
491	28	858	68	1147	25	1488	53	2173	41	3075	47	4896	48	B1073	93
504	69	866	29	1149	33	1490	55	2175	55	3258	29	5130	79	B1081	97
564	42	867	29	1150	37	1493	56	2176	55	3365	66	5131	79	B1083	93
571	50	869	29	1154	34	1498	54	2378	78	3370	46	5132	38	B1102	93
574	48	879	12	1155	33	1502	55	2433	12	3372	46	5133	38	B1121	99
578	48	883	70	1156	33	1503	55	2434	12	3413	61	5135	37	B1129	100
582	60	896	48	1157	33	1504	56	2439	12	3416	61	5136	56	B1130	100
586	48	902	33	1158	37	1507	21	2440	12	3431	28	5141	21	B1131	96
607 / 607A	71	903	33	1159	20	1508	21	2442	14	3475	71	5142	38	B1150	98
619	21	905	68	1161	19	1509	21	2444	14	3491	78	5143	38	B1155	96
620	21	906	63	1165	64	1510	20	2445	12	3497	79	5144	38	B1157	96
621	19	907	26	1166	63	1511	22	2448	14	3498	78	5145	71	B1165	99
622	19	911	28	1167	64	1512	20	2449	14	3499	78	5146	71	B1166	99
632	28	925	22	1170	64	1513	20	2450	12	3600	81	5147	37	B1173	100
641	22	926	22	1171	64	1517	20	2451	14	3603	41	5170	34	B1174	100
645	20	927	22	1172	20	1528	73	2454	14	3612	81	5182	71	B1180	99
671	25	932	73	1173	78	1543	73	2456	15	3613	26	9168	66	B1181	99
672	71	937	42	1174	78	1546	34	2459	17	3614	26	Cylinder 6000	56	B1195	97
679	28	944	50	1176	66	1547	34	2460	17	3618	25	6050	85	B1204	100
688	25	962	31	1177	64	1549	75	2461	17	3619	25	6051	85	B1205	97
717	28	967	32	1180	68	1550	47	2462	17	3620	26	6052	85	B1401	98
720	76	977	23	1181	64	1551	47	2463	17	3622	27	6053	85	B1402	98
734	76	978	22	1181NVL	64	1553	47	2471	15	3623	26	6054	17	B1485	98
745	76	985	73	1182	63	1554	47	2488	14	3624	25	6056	87	B1486	98
751	54	997	73	1183	68	1557	66	2491	15	3625	26	6057	87	B1493	98
754	12	1005	50	1184	69	1558	21	2494	15	3628	26	6057	87	B1493	98
768	59	1011	61	1185	63	1563	12	2495	15	3630	25	6058	85	B1502	98
769	59	1013	73	1190	55	1578	42	2496	15	3651	42	6059	87	B1550	97
770	59	1027	63	1192	73	1579	42	2519	14	3652	42	6060	90	B1551	97
777	57	1028	63	1193	64	1600	69	2520	14	3665	61	6061	90	B1761	98
782	48	1053	53	1194	75	1601	64	2520	14	3679	19	6062	88	B1979	97
796	34	1065	55	1195	75	1601	64	2563	15	3754	71	6063	88	B2156	95
797	23	1069	45	1196	33	1637	61	2564	15	3900	70	6064	90	B2439	94
798	23	1073	31	1197	50	1681	27	2568	15	3960	75	6065	90	B2439SP	94
799	19	1078	70	1203	46	1684	26	2586	75	3979	29	6066	90	B2450	94
807	41	1081	55	1204	37	1736	60	2587	75	3981	28	6067	90	B2451	94
808	45	1083	31	1205	45	1752	69	2618	50	3998	71	6068	87	B2454	94
809	20	1085	31	1206	45	1753	54	2621	50	4013	43	6069	88	B2561	94
810	19	1089	45	1207	45	1756	54	2623	50	4013	43	6070	88	B2621	93
812	34	1100	32	1217	73	1759	54	2629	50	4064	46	6080	85	B3056	97
813	81	1102	32	1233	32	1761	54	2630	50	4085	46	6081	87	B3064	97
814	19	1103	32	1238	78	1778	53	2709	66	4088	29	6082	87	B3603	95
						1783	53	2723	66	4091	37	7000-7014	38/39	B3613	96





[KIRKPATRICK.CO.UK](http://KIRKPATRICK.CO.UK)

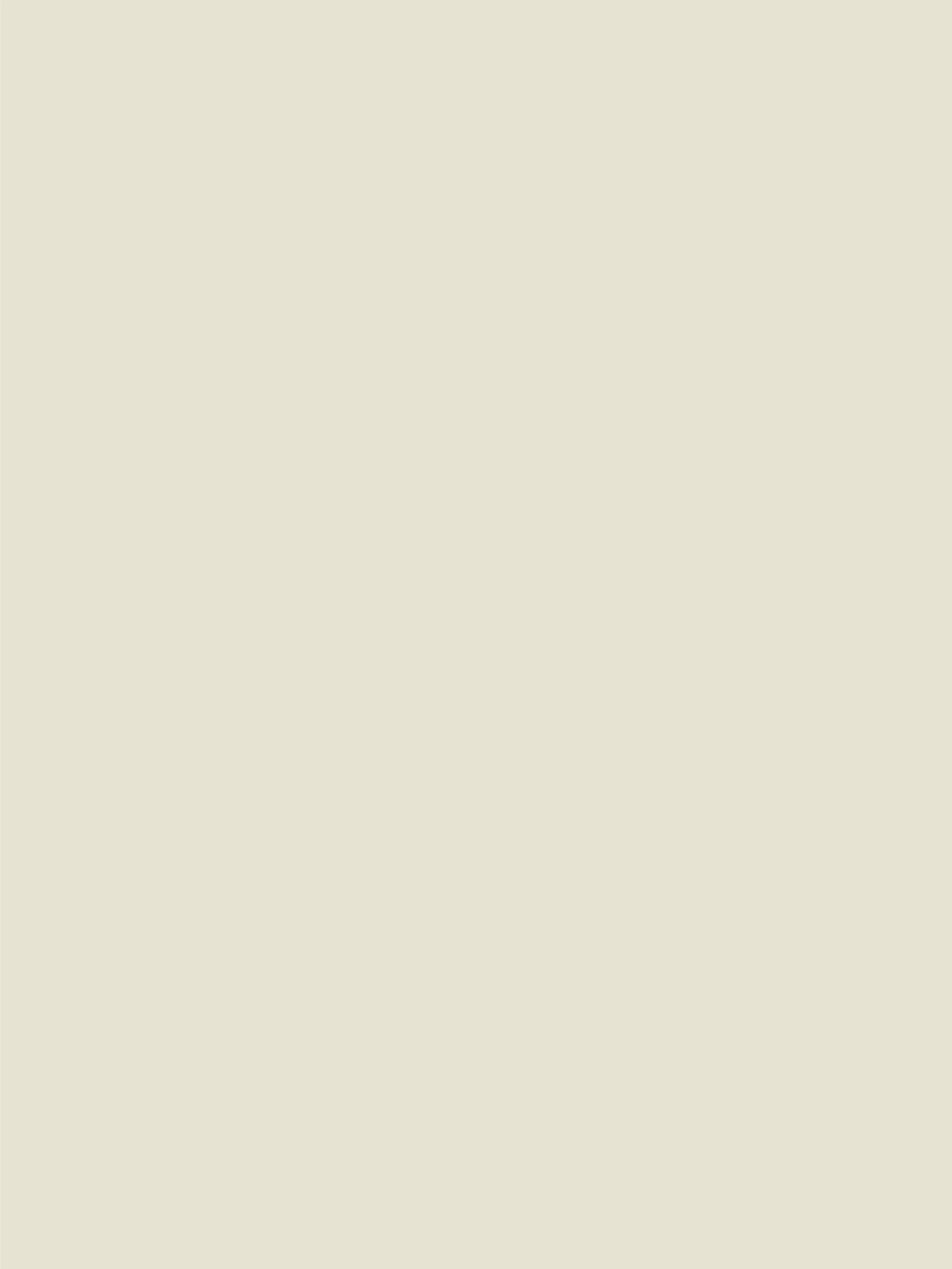



**KIRKPATRICK.CO.UK**

Kirkpatrick, PO Box 17  
Frederick Street, Walsall  
WS2 9NF United Kingdom

Tel +44 (0)1922 620 026  
Fax +44 (0)1922 722 525  
Email [enquiries@kirkpatrick.co.uk](mailto:enquiries@kirkpatrick.co.uk)

*February 2016. We are constantly reviewing and updating  
the range which may be subject to alteration without notice*

